



# governmentattic.org

*"Rummaging in the government's attic"*

Description of document: Defense Intelligence Agency report, Biological Warfare Capabilities -Asian Communist Countries, 30 June 1974

Requested date: 23-October-2008

Released date: 10-June-2013

Posted date: 13-August-2013

Source of document: Commander  
US Army Intelligence & Security Command Freedom of Information/Privacy Office  
ATTN: IAMG-C-FOI  
4552 Pike Road  
Fort George G. Meade, MD 20755-5995  
Fax: (301) 677-2956  
Email: [FOIA/Privacy Office](#)  
[Online FOIA Request Form](#)

Note: This report is one of 16 reports released under Mandatory Declassification Review by the US Army Intelligence & Security Command. All of these reports may be accessed here: <http://www/governmentattic.org/inscomBWCW.html>

The governmentattic.org web site ("the site") is noncommercial and free to the public. The site and materials made available on the site, such as this file, are for reference only. The governmentattic.org web site and its principals have made every effort to make this information as complete and as accurate as possible, however, there may be mistakes and omissions, both typographical and in content. The governmentattic.org web site and its principals shall have neither liability nor responsibility to any person or entity with respect to any loss or damage caused, or alleged to have been caused, directly or indirectly, by the information provided on the governmentattic.org web site or in this file. The public records published on the site were obtained from government agencies using proper legal channels. Each document is identified as to the source. Any concerns about the contents of the site should be directed to the agency originating the document in question. GovernmentAttic.org is not responsible for the contents of documents published on the website.



**DEPARTMENT OF THE ARMY**  
**UNITED STATES ARMY INTELLIGENCE AND SECURITY COMMAND**  
**FREEDOM OF INFORMATION/PRIVACY OFFICE**  
**FORT GEORGE G. MEADE, MARYLAND 20755-5995**

REPLY TO  
ATTENTION OF:

Freedom of Information/  
Privacy Office

10 JUN 2013

This is in further response to your Freedom of Information Act (FOIA) request of October 23, 2008, and supplements our electronic message of May 12, 2010.

Coordination has been completed with another element of our command and other government agencies and records returned to this office for our review and direct response to you. We have reviewed the records and determined the records are partially releaseable to you. A copy of the records are enclosed for your use.

We have completed a mandatory declassification review in accordance with Executive Order (EO) 13526. As a result of our review information has been sanitized and 4 pages have been withheld in their entirety as the information is currently and properly classified TOP SECRET, SECRET and CONFIDENTIAL according to Sections 1.2(a)(1), 1.2(a)(2), 1.2(a)(3) and 1.4(c) of EO 13526. This information is exempt from the public disclosure provisions of the FOIA pursuant to Title 5 U.S. Code 552 (b)(1). It is not possible to reasonably segregate meaningful portions of the withheld pages for release. The records are enclosed for your use. A brief explanation of the applicable sections follows:

Section 1.2(a)(1) of EO 13526, provides that information shall be classified TOP SECRET if its unauthorized disclosure reasonably could be expected to cause exceptionally grave damage to the national security.

Section 1.2(a)(2) of EO 13526, provides that information shall be classified SECRET if its unauthorized disclosure reasonably could be expected to cause serious damage to the national security.

Section 1.2(a)(3) of EO 13526, provides that information shall be classified CONFIDENTIAL if its unauthorized disclosure reasonably could be expected to cause serious damage to the national security.

Section 1.4(c) of EO 13526, provides that information pertaining to intelligence activities, intelligence sources or methods, and cryptologic information shall be considered for classification protection.

In addition, information has been sanitized from the records and 4 pages have been withheld in their entirety as the release of the information would reveal sensitive intelligence methods. This information is exempt from public disclosure pursuant to Title 5 U.S. Code 552 (b)(7)(E) of the FOIA. The significant and legitimate governmental purpose to be served by withholding is that a viable and effective intelligence investigative capability is dependent upon protection of sensitive investigative methodologies. It is not possible to reasonably segregate meaningful portions of the withheld pages for release.

The withholding of the information described above is a partial denial of your request. This denial is made on behalf of Major General Stephen G. Fogarty, the Commanding General, U.S. Army Intelligence and Security Command, who is the Initial Denial Authority for Army intelligence investigative and security records under the FOIA. You have the right to appeal this decision to the Secretary of the Army. Your appeal must be postmarked no later than 60 calendar days from the date of this letter. After the 60-day period, the case may be considered closed; however, such closure does not preclude you from filing litigation in the courts. You should state the basis of your disagreement with the response and provide justification for a reconsideration of the denial. An appeal may not serve as a request for additional or new information. An appeal may only address information denied in this response. Your appeal is to be made to this office, for forwarding, as appropriate to the Secretary of the Army, Office of the General Counsel.

Coordination has been completed and we have been informed by the Central Intelligence Agency (CIA) that information is exempt from public disclosure pursuant to Title 5 U.S. Code 552 (b)(1) and (b)(3) of the FOIA.

The withholding of the information by the CIA constitutes a denial of your request and you have the right to appeal this decision to the Agency Release Panel within 45 days from the date of this letter. If you decide to file an appeal, it should be forwarded to this office and we will coordinate with the CIA on your behalf. Please cite CIA #F-2010-01292/Army #57F-09 assigned to your request so that it may be easily identified.

Coordination has been completed and we have been informed by the Defense Intelligence Agency (DIA) that their information is exempt from public disclosure pursuant to Title 5 U.S. Code § 552 (b)(1), (b)(2) (b)(3) and (b)(4) of the Freedom of Information Act and Executive Order (EO) 13,526 § 1.4 (c) (d) and (h). The statute invoked under Title 5 U.S. Code 552 (b)(3) is 10 U.S.C. §424, which allows for the protection of organizational and personnel information for DIA.

The withholding of the information by the DIA constitutes a partial denial of your request and you have the right to appeal this decision directly to the DIA. If you decide to file an appeal, it should be forwarded to the Director, Defense Intelligence Agency, ATTN: DAN-1A-FOIA, Washington, DC 20340-5100. Please cite MDR #0155-2010 assigned to your request so that it may be easily identified.

You have received all Army intelligence investigative records pertaining to this request.

There are no assessable FOIA fees.

If you have any questions regarding this action, feel free to contact this office at 1-866-548-5651, or email the INSCOM FOIA office at: [INSCOM\\_FOIA\\_ServiceCenter@mi.army.mil](mailto:INSCOM_FOIA_ServiceCenter@mi.army.mil) and refer to case #57F-09.

Sincerely,

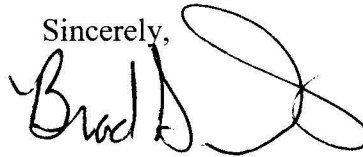
A handwritten signature in black ink, appearing to read "Brad S. Dorris". The signature is stylized with a large, looping flourish at the end.

Brad S. Dorris  
Director  
Freedom of Information/Privacy Office  
Investigative Records Repository

Enclosure

AUG 30 1974

28 AUG 1974

CIRC.

ST-CS-03-148-75

~~SECRET~~



FC74-027287  
SECRET XGDS  
NFD



# DEFENSE INTELLIGENCE AGENCY

## BIOLOGICAL WARFARE CAPABILITIES— ASIAN COMMUNIST COUNTRIES (U)

NO FOREIGN DISSEM

CLASSIFIED BY CDR, USAF/TC  
EXEMPT FROM GDS OF EO 11652  
EXEMPTION CATEGORY: 1,2,3  
DECLASSIFY ON: INFOET

Cy  
ST-S-4-2704  
~~SECRET~~

573

~~SECRET~~

**BIOLOGICAL WARFARE CAPABILITIES—  
ASIAN COMMUNIST COUNTRIES (U)**

(b)(6)

**ST-CS-03-148-75**

(b)(3):10 U.S.C. 424

**DATE OF PUBLICATION**

July 1974

Information Cutoff Date

30 June 1974

This study supersedes ST-CS-03-148-72, dated March 1972, Amendment A, dated October 1972, and Amendment B, dated July 1973.

**NATIONAL SECURITY INFORMATION**  
Unauthorized disclosure subject to  
criminal sanctions

This is a Department of Defense Intelligence Document prepared by the Foreign Science and Technology Center of the US Army Materiel Command with contributions from the Defense Intelligence Agency, the Naval Intelligence Support Center, the Foreign Technology Division of the US Air Force Systems Command, and the US Army Medical Intelligence and Information Agency, and approved by the Directorate for Scientific and Technical Intelligence of the Defense Intelligence Agency.

**NO FOREIGN DISSEM**

Classified by Cdr. USAFSTC  
Exempt from GDS of EO 11652  
Exemption Category 1, 2, 3  
Declassify on IMPDET

574

(Reverse Blank)

~~SECRET~~

(This page is UNCLASSIFIED)

~~CONFIDENTIAL~~

Original

ST-CS-83-148-75

PREFACE

(U) The purpose of this publication is to assess all information concerning the biological warfare capabilities of the People's Republic of China, North Vietnam, North Korea, and Mongolia. For each of these countries information is included concerning: order of battle for biological warfare; identification and description of biological warfare materiel; production installations and capabilities; stockpiles and storage facilities; doctrine and procedures that would govern the use of biological warfare; defensive measures to be taken in the event biological warfare were initiated; and applicable research, development, and testing programs.

(b)(1)

(U) Constructive criticisms, comments, or suggested changes are encouraged, and should be forwarded to the Defense Intelligence Agency, Washington, DC 20301

(b)(3):10 U.S.C. 424

575

iii

~~CONFIDENTIAL~~

ST-OS-83-148-74

~~CONFIDENTIAL~~

Original

(This page intentionally left blank)

576

iv

~~CONFIDENTIAL~~  
(This page is UNCLASSIFIED)



# UNCLASSIFIED

Original

ST-ES-03-148-75

## LIST OF EFFECTIVE PAGES

SUBJECT MATTER	PAGE NUMBERS	DATE
Title Page	None	July 1974
Preface	iii (Reverse Blank)	Original
List of Effective Pages	v (Reverse Blank)	Original
Record of Changes	vii (Reverse Blank)	Original
Table of Contents	ix thru xiii	Original
List of Illustrations	xiv	Original
List of Tables	xi	Original
List of Abbreviations	xv (Reverse Blank)	Original
Summary	xvii thru xx	Original
Section I	1 thru 60	Original
Section II	61 thru 72	Original
Section III	73 thru 86	Original
Section IV	87 thru 92	Original
Appendix I	93 thru 106	Original
Appendix II	107 thru 126	Original
Appendix III	127 thru 133 (Reverse Blank)	Original
Appendix IV	135 thru 140	Original
Appendix V	141 thru 150	Original
Appendix VI	151 thru 154	Original
Appendix VII	155 and 156	Original
DD Form 1473	157 and 158	Original
Distribution List	159 (Reverse Blank)	Original

577

v

(Reverse Blank)

# UNCLASSIFIED

**UNCLASSIFIED**

Original

ST-CS-03-148-75

RECORD OF CHANGES

CHANGE NUMBER	DATE OF CHANGE	DATE ENTERED	SIGNATURE, RANK/RATE AND ORGANIZATION OF INDIVIDUAL ENTERING CHANGE

578

vii  
(Reverse Blank)

**UNCLASSIFIED**

# UNCLASSIFIED

Original

ST-CS-03-148-75

## TABLE OF CONTENTS

	Page
Preface .....	iii
Summary .....	xvii
<b>SECTION I. PEOPLE'S REPUBLIC OF CHINA</b>	
<b>A. INTRODUCTION</b>	
1. Historical Background .....	1
2. Competence in Microbiology and Public Health .....	2
3. Geographical and Political Factors .....	3
<b>B. ORDER OF BATTLE</b>	
4. Military Organization .....	6
5. Military Equipment .....	9
6. Military Training .....	13
7. Naval BW Operational Capabilities .....	17
8. Aerospace BW Operational Capabilities .....	20
<b>C. POLICY, STRATEGY, AND TACTICS REGARDING USE OF BW</b>	
9. Policy .....	21
10. Procedures .....	21
<b>D. POLICY, STRATEGY, AND TACTICS REGARDING DEFENSE AGAINST BW</b>	
11. Policy .....	22
12. Procedures .....	22
<b>E. BW MATERIEL (OFFENSIVE)</b>	
13. Agents .....	23
14. Delivery Systems .....	23

# UNCLASSIFIED

# UNCLASSIFIED

ST-CS-03-148-75

Original

## TABLE OF CONTENTS (Continued)

	Page
<b>F. BW MATERIEL (DEFENSIVE)</b>	
15. Decontamination .....	25
16. Detection and Identification .....	26
17. Medical Protection .....	27
<b>G. PRODUCTION FACILITIES</b>	
18. Agents and Munitions .....	28
19. Defensive Equipment .....	28
<b>H. BW RESEARCH, DEVELOPMENT, AND TESTING</b>	
20. General .....	29
21. Military Facilities .....	29
22. Non-Military Facilities .....	34
23. Potential Agent Development .....	41
24. Molecular Biology as Related to BW Agent Research and Development .....	43
25. Biofermentation/Bioengineering as Related to BW Agent Developments .....	46
26. Preservation of Microorganisms as Related to BW Agent Development .....	48
27. Testing .....	49
<b>I. ANTICROP RESEARCH</b>	
28. General .....	49
29. Major Crops .....	51
30. R&D Against Naturally Occurring Crop Pests and Anticrop Warfare Agents .....	51
31. Assessment of the People's Republic of China Anticrop BW Capabilities .....	55

x

# UNCLASSIFIED

580

# UNCLASSIFIED

Original

ST-CS-03-148-75

## TABLE OF CONTENTS (Continued)

	Page
J. CONCLUSIONS	
32. Offensive Posture .....	55
33. Defensive Posture .....	56
K. TRENDS AND FORECASTS	
34. Trends .....	56
35. Forecasts .....	57
SECTION II. NORTH VIETNAM	
A. INTRODUCTION	
1. Historical Background and Competence in Microbiology .....	61
2. Geographical and Political Factors .....	62
B. ASSESSMENT	
3. Order of Battle .....	63
4. Doctrine and Procedures .....	66
5. BW Equipment .....	67
6. Production and Stockpiling .....	68
7. Research, Development, and Testing .....	68
8. Conclusions .....	70
9. Trends and Forecasts .....	70
SECTION III. NORTH KOREA	
A. INTRODUCTION	
1. Historical Background and Competence in Microbiology .....	73
2. Geographical and Political Factors .....	73

# UNCLASSIFIED

UNCLASSIFIED

ST-CS-83-148-75

Original

TABLE OF CONTENTS (Continued)

B. ASSESSMENT

	Page
3. Order of Battle .....	74
4. Doctrine and Procedures .....	79
5. BW Equipment .....	80
6. Production and Stockpiling .....	80
7. Naval BW Operational Capability .....	81
8. Research, Development, and Testing .....	82
9. Conclusions .....	83
10. Trends and Forecasts .....	84

SECTION IV. THE MONGOLIAN PEOPLES REPUBLIC

A. INTRODUCTION

1. Historical Background and Competence in Microbiology .....	87
2. Geographical and Political Factors .....	87

B. ASSESSMENT

3. Order of Battle .....	88
4. Doctrine and Procedures .....	88
5. BW Equipment .....	89
6. Production and Stockpiling .....	89
7. Research, Development, and Testing .....	89
8. Conclusions .....	90
9. Trends and Forecasts .....	90

APPENDIX I. FOMCAT Illustrations and Descriptions of Protective Equipment. People's Republic of China .....	93
--	----

APPENDIX II. Selected Medical Materiel Manufacturers and Medical Laboratories. People's Republic of China (1971) .....	107
---	-----

# UNCLASSIFIED

Original

ST-CS-63-148-75

## TABLE OF CONTENTS (Continued)

	Page
Annex A. Manufacturers of Medical Materiel .....	109
Annex B. Medical Laboratories .....	117
APPENDIX III. FOMCAT Illustrations and Descriptions of Protective Equipment, North Vietnam .....	127
APPENDIX IV. Selected Medical Materiel Manufacturers and Medical Laboratories, North Vietnam (1971) .....	135
Annex A. Manufacturers of Medical Materiel .....	137
Annex B. Medical Laboratories .....	139
APPENDIX V. FOMCAT Illustrations and Descriptions of Protective Equipment, North Korea .....	141
APPENDIX VI. Selected Medical Materiel Manufacturers and Medical Laboratories, North Korea (1971) .....	151
Annex A. Manufacturers of Medical Materiel .....	153
Annex B. Medical Laboratories .....	154
APPENDIX VII. Selected Medical Materiel Manufacturers, Mongolian Peoples Republic (1971) .....	155
DD Form 1473 .....	157
Distribution List .....	159

# UNCLASSIFIED

ST-CS-03-148-75

Original

## LIST OF ILLUSTRATIONS

Figure	Page
1. BW organization in the PRC	7
2. CBR reconnaissance troops in light protective clothing	11
3. Vehicle ground decontamination exercises	13
4. Troops preparing to ford stream in full protective clothing	14
5. CW school and research station at Ch'ang-p'ing	15
6. Decontamination exercise at CW school at Ch'ang-p'ing	15
7. Troops in full protective clothing training with detector kits at CW school	16
8. Battle training at sea	18
9. Decontamination exercise aboard ship	18
10. CBR exercise aboard Chinese ship	19
11. North Vietnamese CBR organization	64
12. CBR organization within the North Korean Army	75

## LIST OF TABLES

Table	Page
I. Location of Chemical Units in the PRC	10
II. Basis of Issue for BW Equipment-PRC Army	12
III. Potential BW Agents	42
IV. Suspected Chinese BW Agent Production Facilities	44
V. Acreage and Production of Major Crops in the PRC	51
VI. Location of North Korean Chemical Units	77

xiv

# UNCLASSIFIED

584



# UNCLASSIFIED

Original

ST-CS-03-148-75

## LIST OF ABBREVIATIONS

ASM	air-to-surface missile
BHC	benzene hexachloride
BW	biological warfare
CAMS	Chinese Academy of Medical Sciences
CAS	Chinese Academy of Sciences
CBR	chemical, biological, and radiological
CCP	Chinese Communist Party
CPLA	Chinese People's Liberation Army
CW	chemical warfare
DNA	deoxyribonucleic acid
DRV	Democratic Republic of Vietnam
GSD	General Staff Department
ICBM	intercontinental ballistic missile
IRBM	intermediate range ballistic missile
JBE	Japanese B encephalitis
MAC	Military Affairs Committee
MOD	Ministry of National Defense
MPH	Ministry of Public Health
MRBM	medium range ballistic missile
NKA	North Korean Army
NKN	North Korean Navy
NVA	North Vietnamese Army
PLA	People's Liberation Army
PRC	People's Republic of China
PRCN	People's Republic of China Navy
RNA	ribonucleic acid
VC	Viet Cong

xv

(Reverse Blank)

# UNCLASSIFIED

585

~~CONFIDENTIAL~~

ST-CS-83-148-75

Original

SUMMARY

(b)(1)

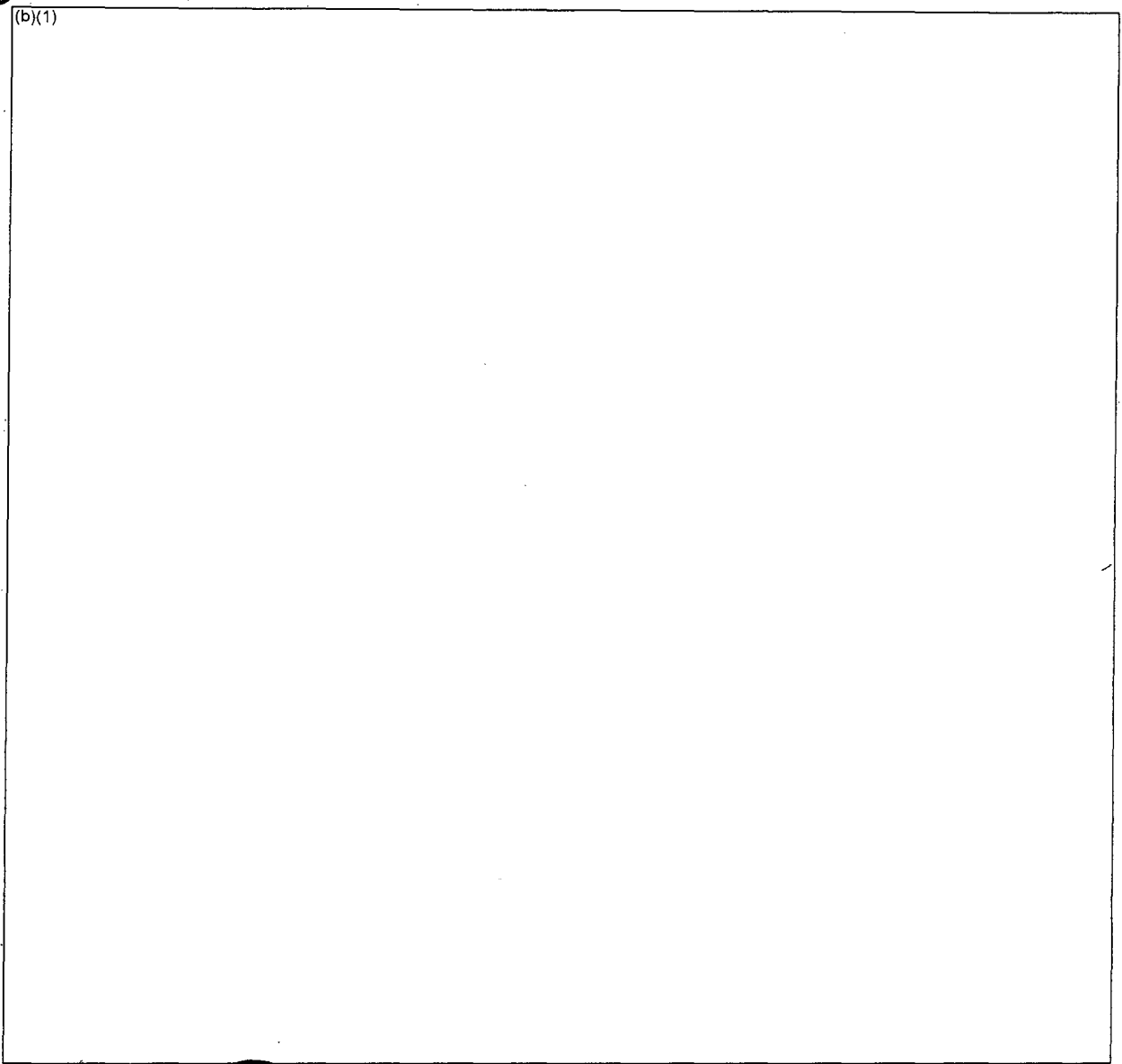

NO FOREIGN DISSEM

xvii

~~CONFIDENTIAL~~

586

**CONFIDENTIAL**

ST-CS-03-148-75

Original

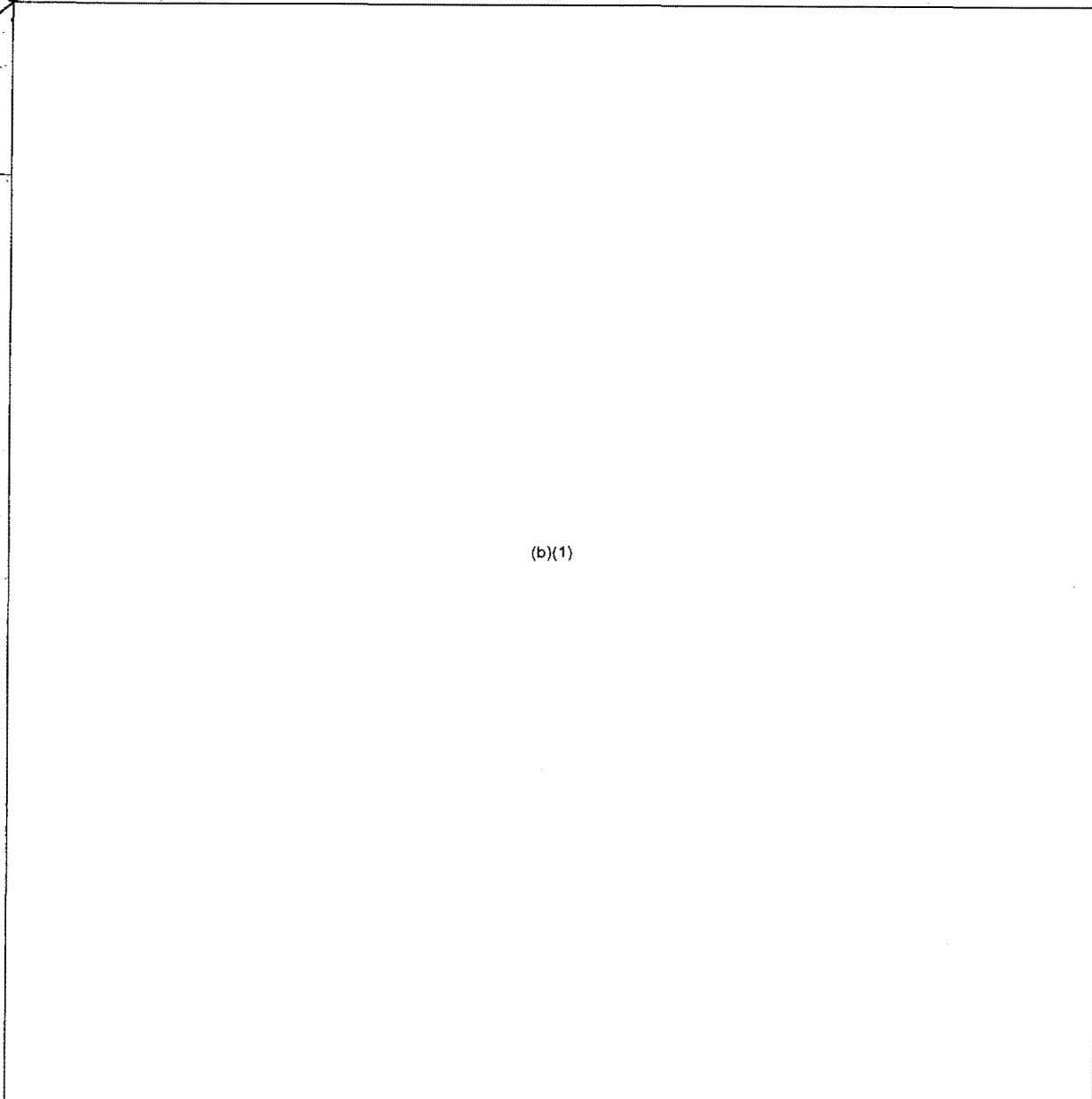

(b)(1)

NO FOREIGN DISSEM

xviii

**CONFIDENTIAL**

587

**CONFIDENTIAL**

ST-CS-03-148-75

Original

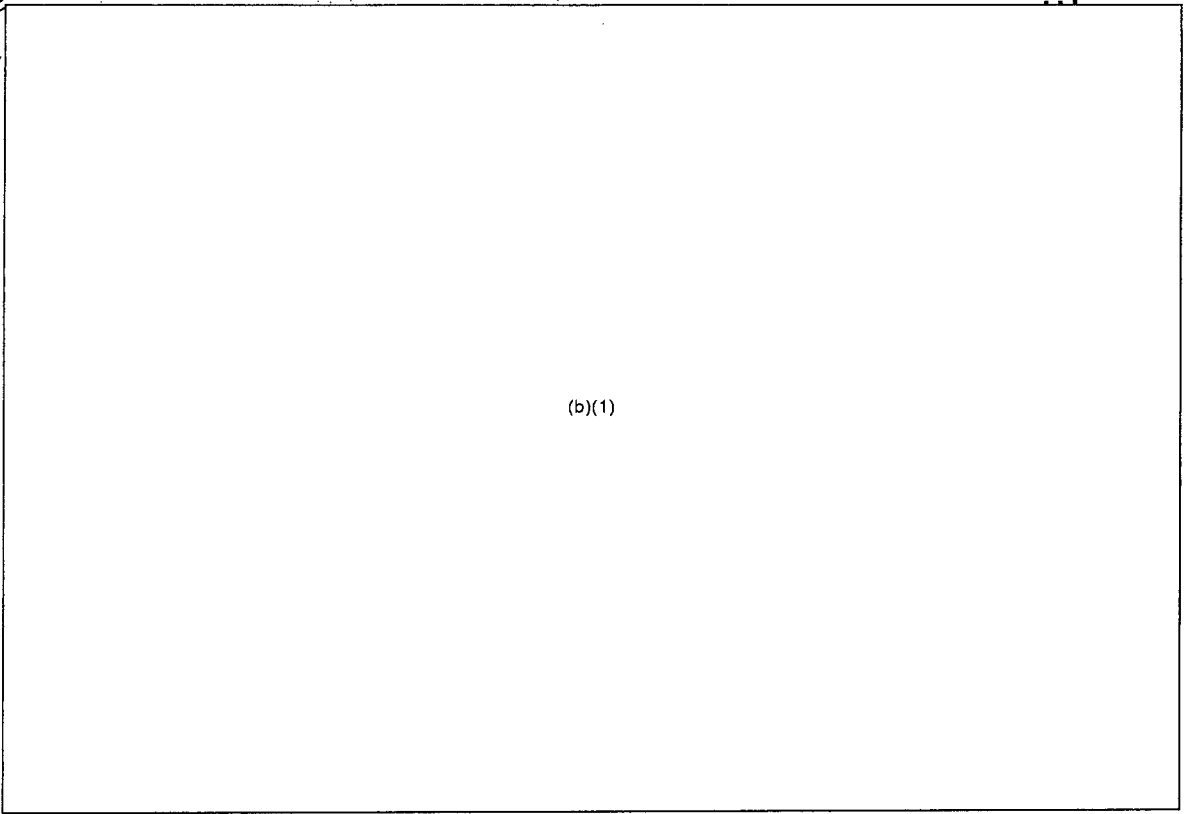

(b)(1)

xix

**CONFIDENTIAL**

588

ST-CS-83-148-75

~~CONFIDENTIAL~~

Original

(This page intentionally left blank)

xx

~~CONFIDENTIAL~~  
(This page is UNCLASSIFIED)

589

~~CONFIDENTIAL~~

ST-CS-01-148-75

Original

Section I.

PEOPLE'S REPUBLIC OF CHINA

---

A. INTRODUCTION

1. ~~HA~~ Historical Background

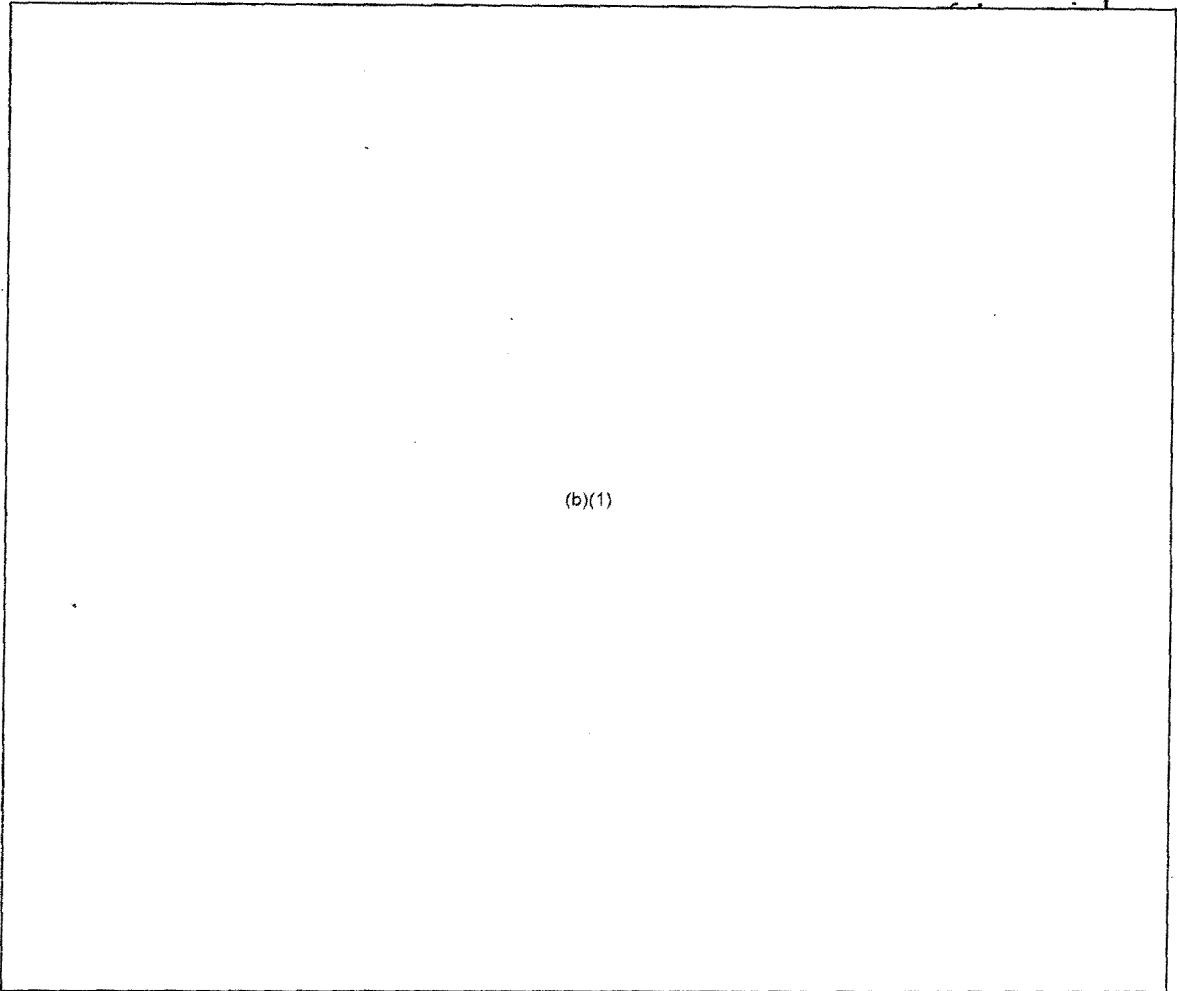

(b)(1)

~~CONFIDENTIAL~~

590

~~CONFIDENTIAL~~

~~A~~ ST-CS-03-148-75

Original

(b)(1)

2. ~~A~~ Competence in Microbiology and Public Health

(b)(1)

2

~~CONFIDENTIAL~~

591

~~CONFIDENTIAL~~

ST-CS-03-148-75

~~Original~~

(b)(1)

(b)(1)

3. ~~(C)~~ Geographical and Political Factors u

a. (U) The PRC is the third largest country in the world, occupying about 3.7 million square miles, and the population comprises about one-fifth that of the world. To the north and west, an extensive boundary is shared with the Soviet Union, a boundary which separates the two most powerful Communist countries. To the south, China borders on several weak, unstable countries, one being North Vietnam. She has used North Vietnam as a base for Communist operations against neighboring countries. China also shares common borders with North Korea, Mongolia, Afghanistan, India, Nepal, Bhutan, Burma, and Laos. The mainland is within 2500 nautical miles of every major target in Asia as well as European USSR. Two-thirds of China's area is mountainous or desert-like, and 90% of the population live in one-sixth of the country, primarily in the fertile plains and deltas of the east.<sup>15</sup>

3

~~CONFIDENTIAL~~

592



~~CONFIDENTIAL~~

ST-CS-03-148-75

Original

(b)(1)

4

~~CONFIDENTIAL~~

593

~~SECRET~~  
CONFIDENTIAL

ST-CS-03-148-75

Original

(b)(1)

c. (U) The PRC has not signed the United Nations agreement entitled "Convention of the Prohibition of the Development, Production, and Stockpiling of Bacteriological (Biological) and Toxin Weapons and Their Destruction," which was signed simultaneously in Washington, London, and Moscow on April 10, 1972. To date, 109 nations have signed, and 34 nations have ratified the Convention. The PRC has not signed because the government did not participate in the Convention and is opposed to the separation of controls on CW and BW. What future action may be taken regarding the Convention is unknown.

594

Regraded CONFIDENTIAL on  
4 JAN 2011

5  
CONFIDENTIAL

by USAINSCOM FOLPA  
Auth para 4-102, DOD 5200-1R

~~SECRET~~  
(This page is CONFIDENTIAL)

~~SECRET~~

ST-CS-03-148-75

Original

B. ORDER OF BATTLE

4. ~~(S)~~ Military Organization

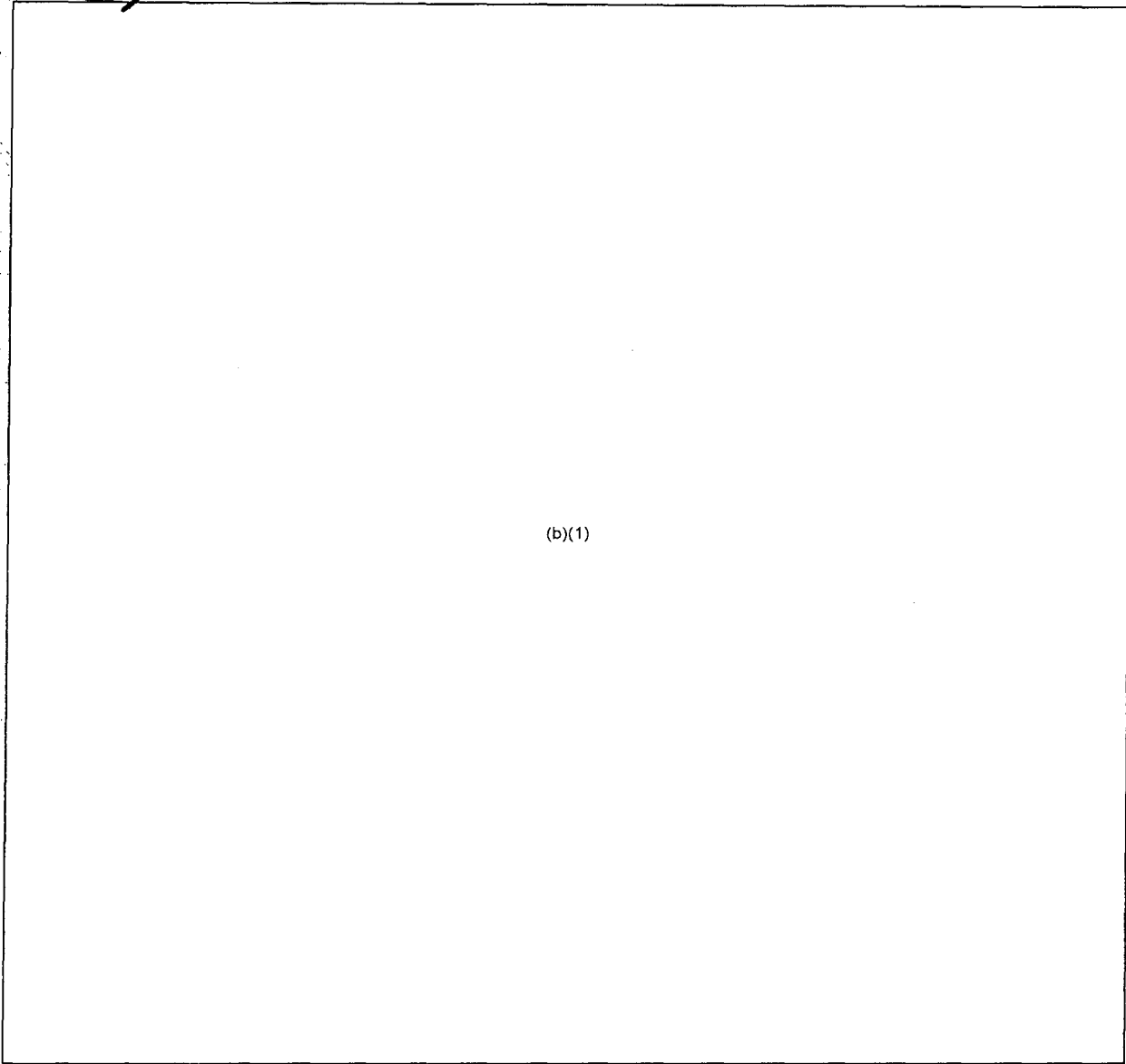

(b)(1)

~~SECRET~~

595

Freedom of Information Act/Privacy Act  
Deleted Page(s) Information Sheet

Indicated below are one or more statements which provide a brief rationale for the deletion of this page.

Information has been withheld in its entirety in accordance with the following exemption(s):

Title 5 USC (b)(1)

It is not reasonable to segregate meaningful portions of the record for release.

Information pertains solely to another individual with no reference to you and/or the subject of your request.

Information originated with another government agency. It has been referred to them for review and direct response to you.

Information originated with one or more government agencies. We are coordinating to determine the releasability of the information under their purview. Upon completion of our coordination, we will advise you of their decision.

Other:

DELETED PAGE(S) NO DUPLICATION FEE FOR THIS PAGE.
---

Page(s) 596+597

~~SECRET~~  
~~CONFIDENTIAL~~

ST-CS-03-148-75

Original

(b)(1)

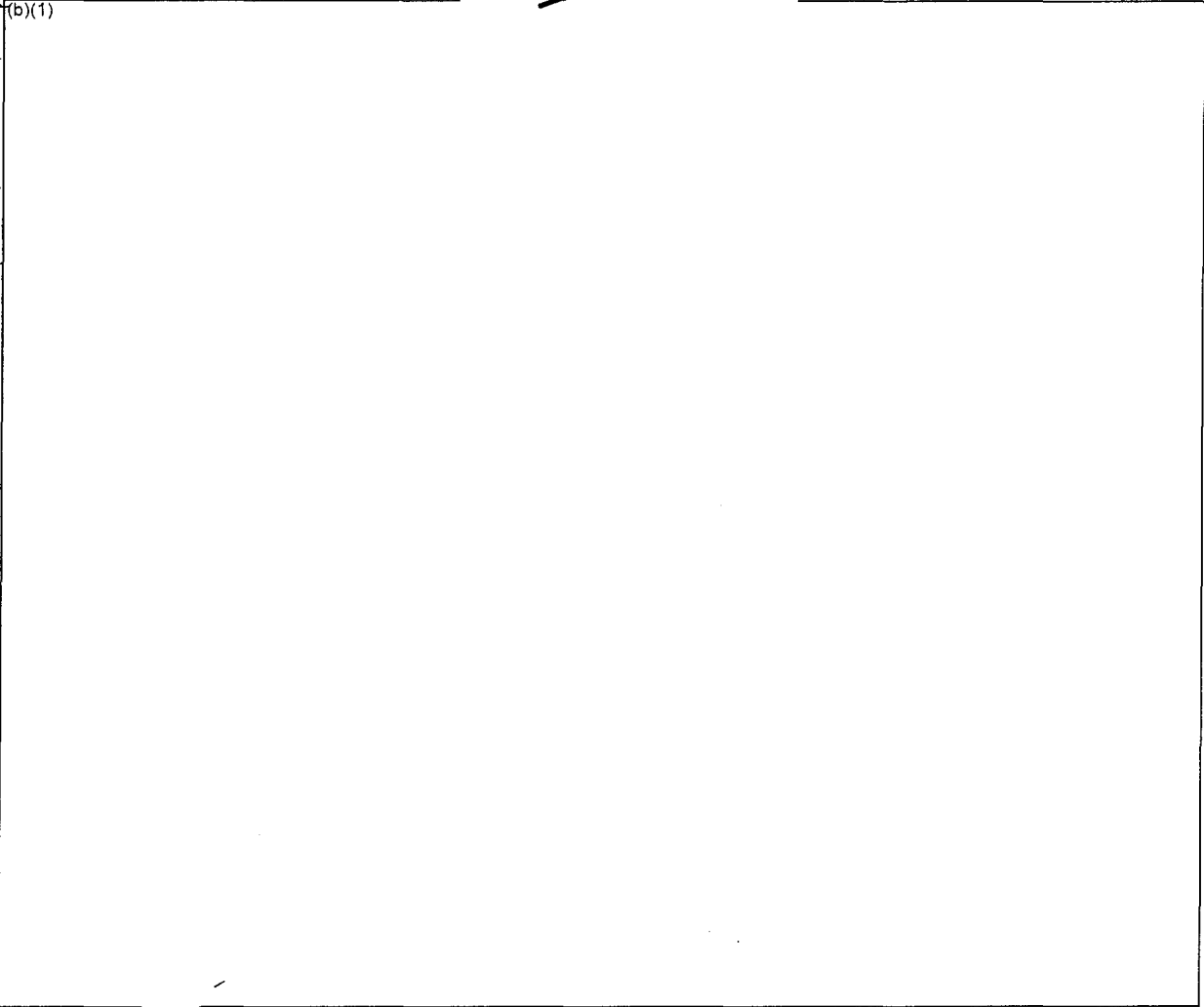

5. ~~RET~~ Military Equipment

(b)(1)

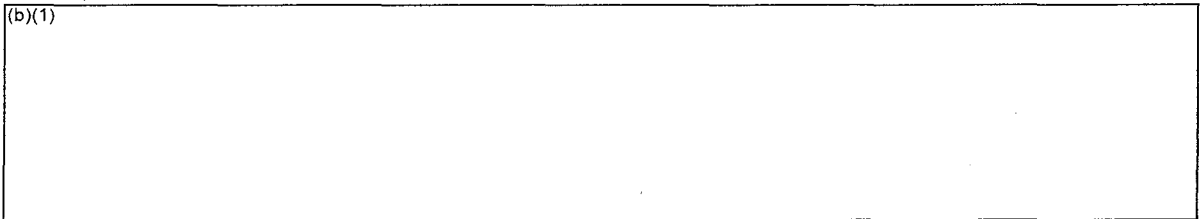

<sup>9</sup>  
~~CONFIDENTIAL~~

~~SECRET~~

(This page is ~~CONFIDENTIAL~~)

598

~~SECRET~~

ST-CS-03-148-75

Original

Table I. Location of Chemical Units in the PRC (U)<sup>2-2\*</sup>

(b)(1)

~~SECRET~~

599

~~SECRET~~  
CONFIDENTIAL

ST-CS-03-148-75

Original

(b)(1)



(UNCLASSIFIED)

Figure 2. CBR reconnaissance troops in light protective clothing (U).

\*See appendix I.

11  
600

~~SECRET~~  
(This page is CONFIDENTIAL.)

Original

~~(SECRET)~~

Table II. Basis of Issue for CBR Equipment—PRC Army. (U) (S)

(b)(1)



~~CONFIDENTIAL~~

ST-CS-03-148-75

Original

6. ~~(S)~~ Military Training

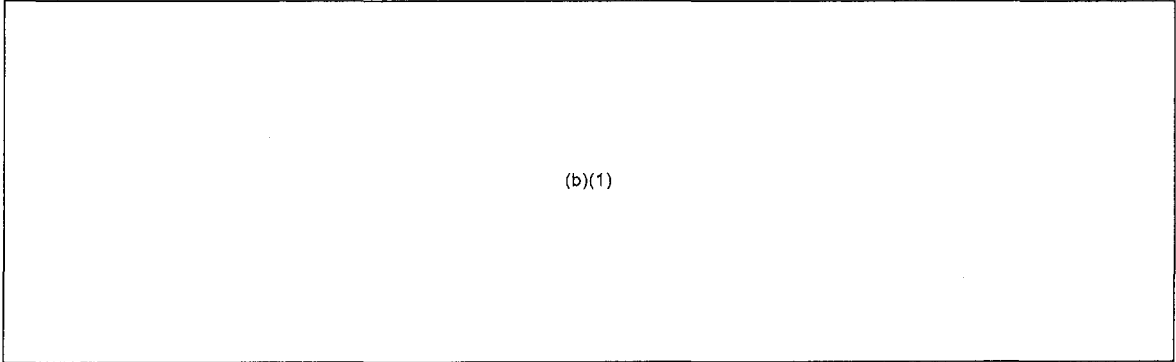

(b)(1)

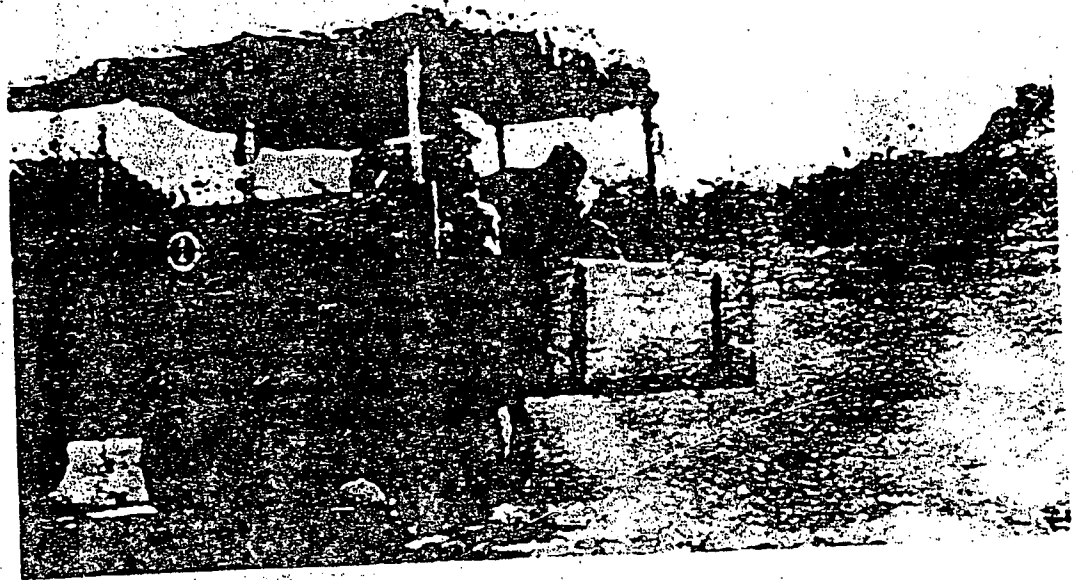

(UNCLASSIFIED)

Figure 3. Vehicle ground decontamination exercises (U).

~~CONFIDENTIAL~~

~~CONFIDENTIAL~~

ST-CS-03-148-75

Original

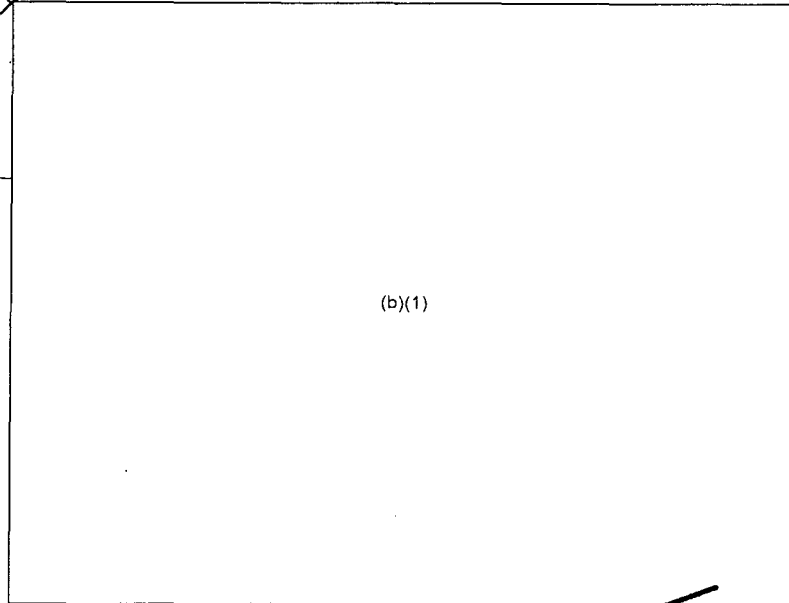

~~(CONFIDENTIAL)~~

Figure 4. Troops preparing to ford stream in full protective clothing (U).

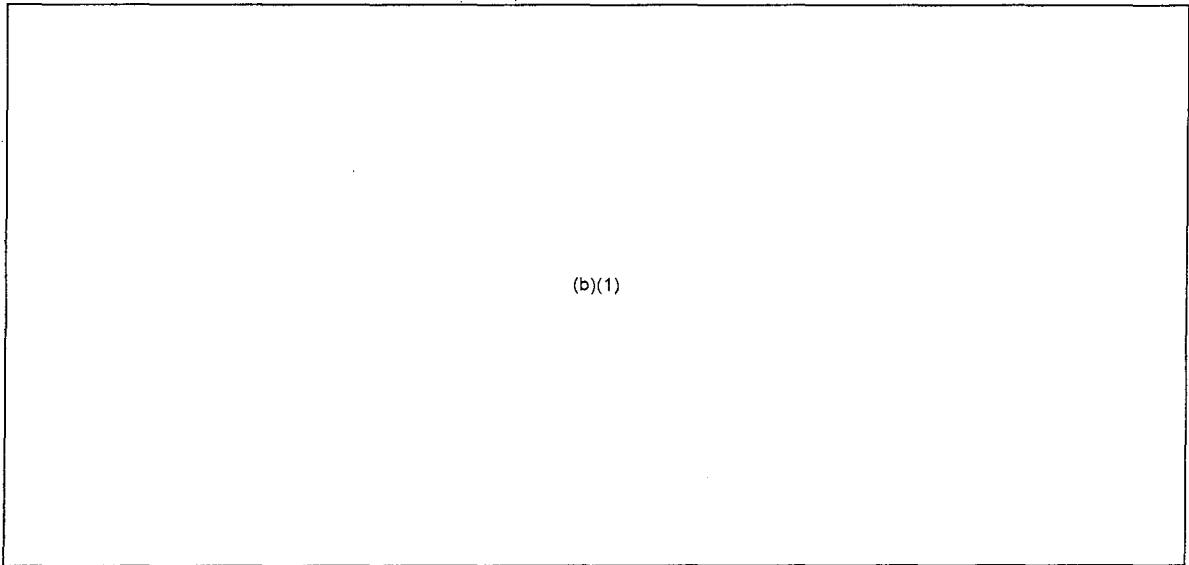

~~CONFIDENTIAL~~

~~CONFIDENTIAL~~

ST-CS-03-148-75

Original

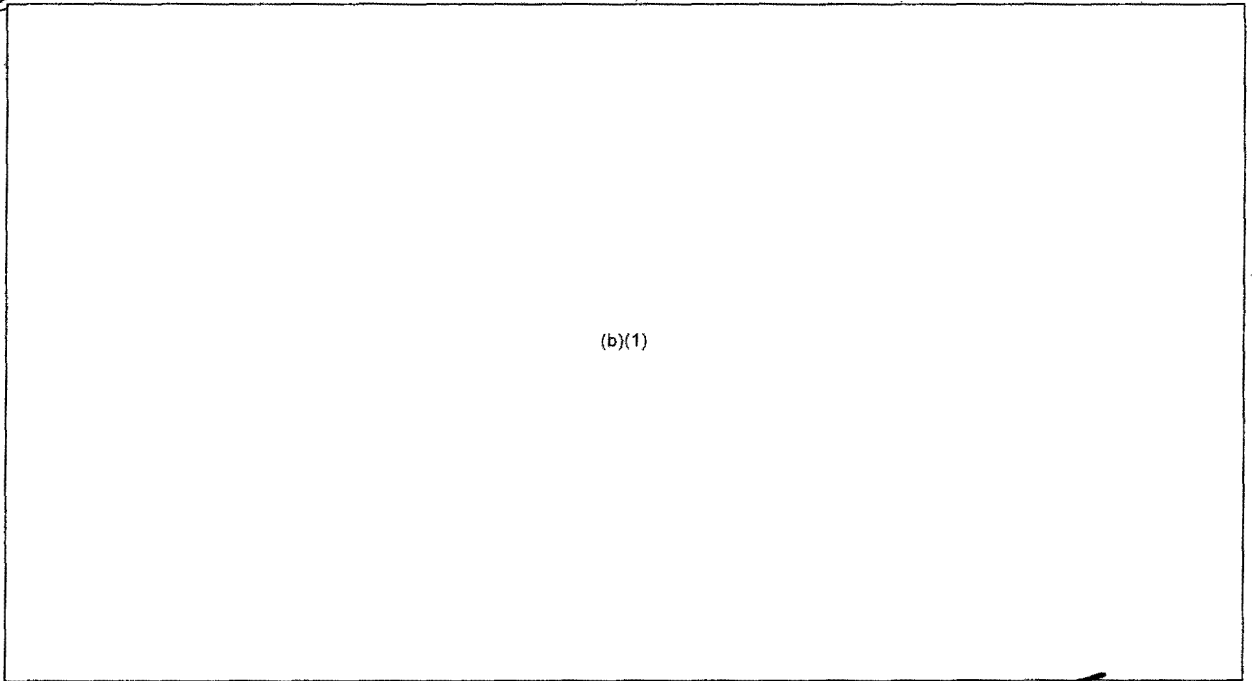

(b)(1)

~~(CONFIDENTIAL)~~

Figure 5. CW school and research station at Ch'ang-p'ing (U).

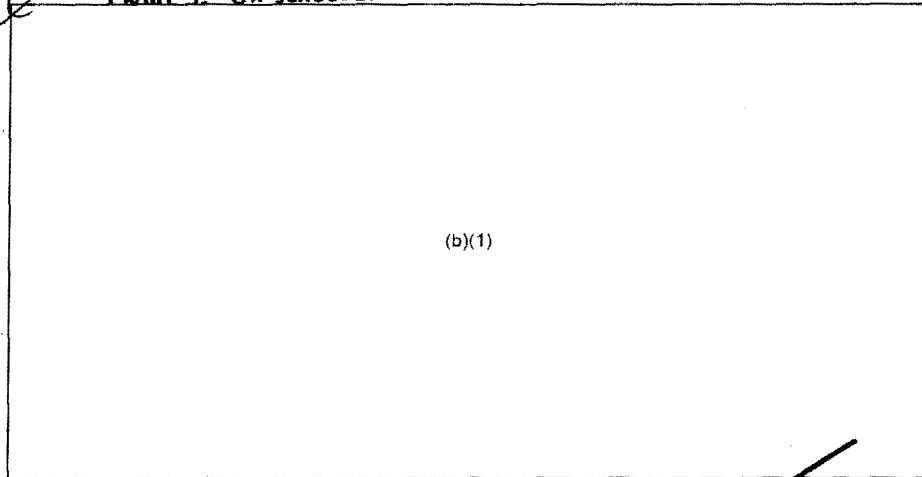

(b)(1)

~~(CONFIDENTIAL)~~

Figure 6. Decontamination exercise at CW school at Ch'ang-p'ing (U).

~~CONFIDENTIAL~~

~~CONFIDENTIAL~~

ST-CS-03-148-75

Original

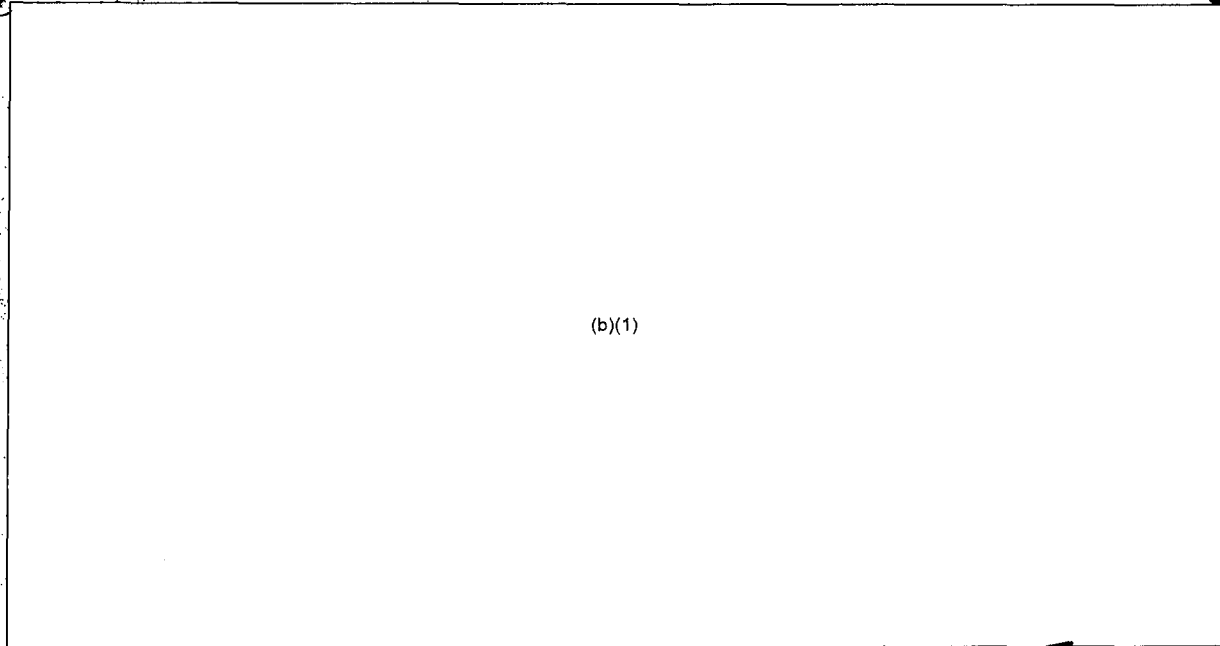

(b)(1)

~~(CONFIDENTIAL)~~

Figure 7. Troops in full protective clothing training with detector kits at CW school (U).

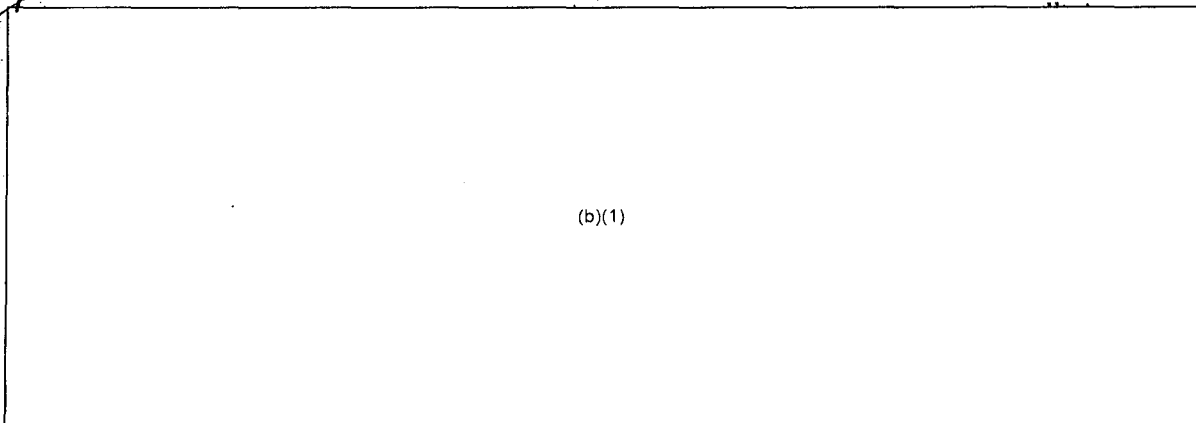

(b)(1)

~~CONFIDENTIAL~~

~~CONFIDENTIAL~~

ST-CS-03-148-75

*Original*

(b)(1)

7. ~~(C/NFD)~~ Naval BW Operational Capabilities

(b)(1)

~~CONFIDENTIAL~~

606

~~CONFIDENTIAL~~

ST-CS-03-148-75

Original

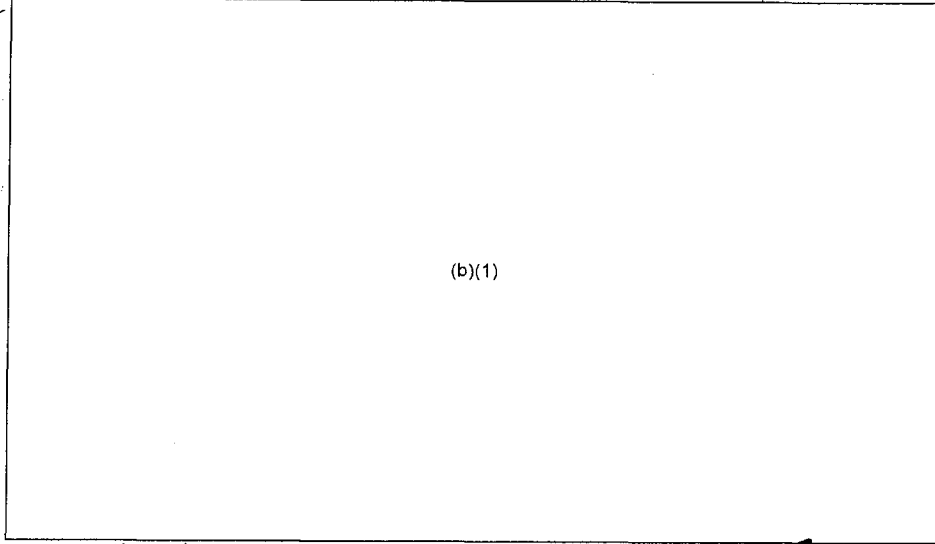

~~(CONFIDENTIAL)~~

Figure 8. Battle training at sea (U).

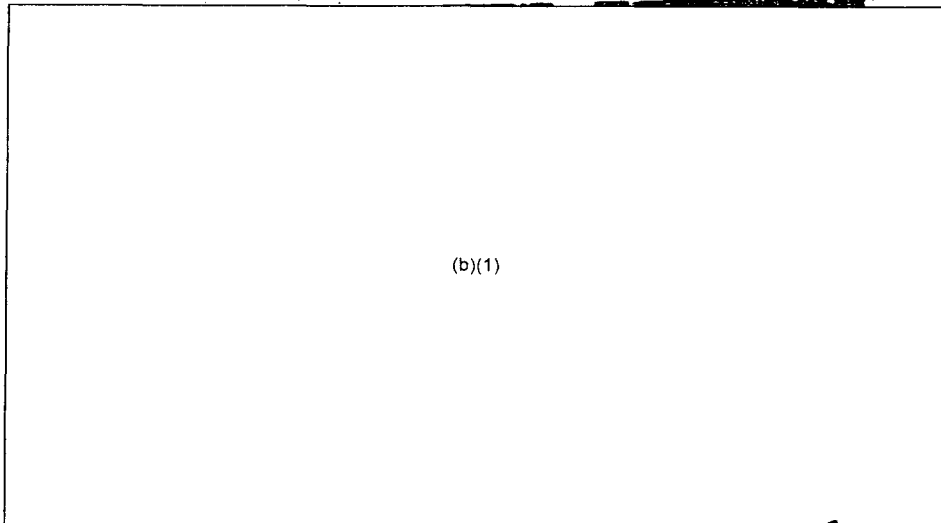

~~(CONFIDENTIAL)~~

Figure 9. Decontamination exercise aboard ship (U).

~~CONFIDENTIAL~~

~~CONFIDENTIAL~~

ST-CS-03-148-75

Original

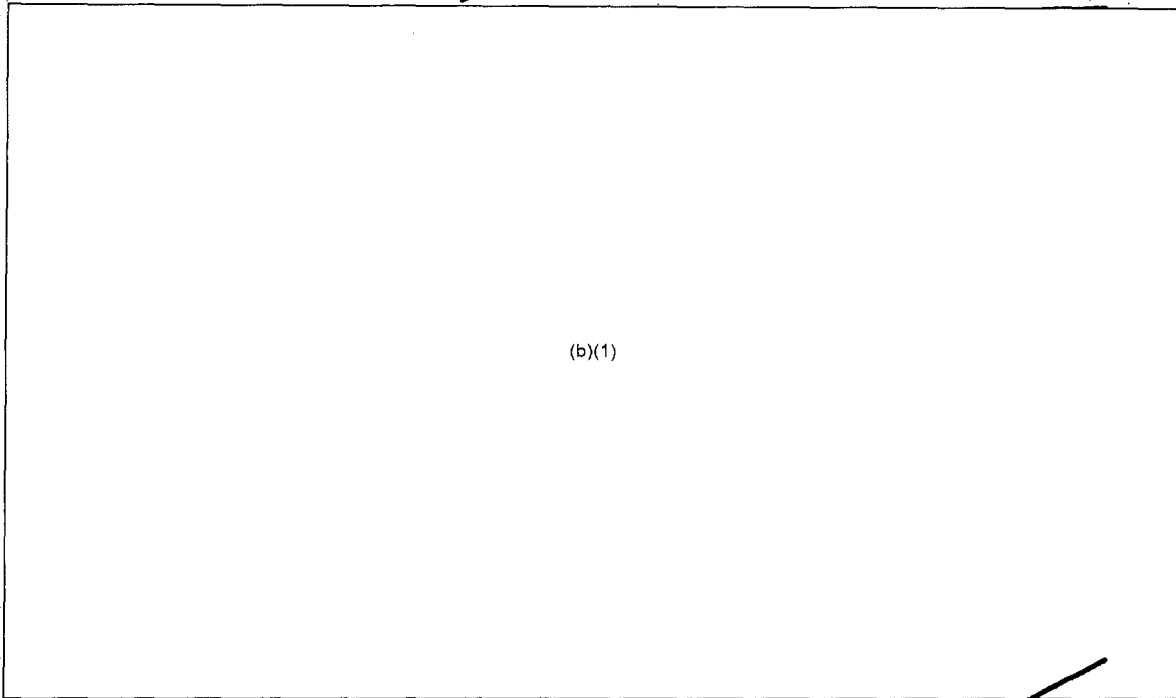

(b)(1)

~~(CONFIDENTIAL)~~

Figure 10. CBR exercise aboard Chinese ship (U).

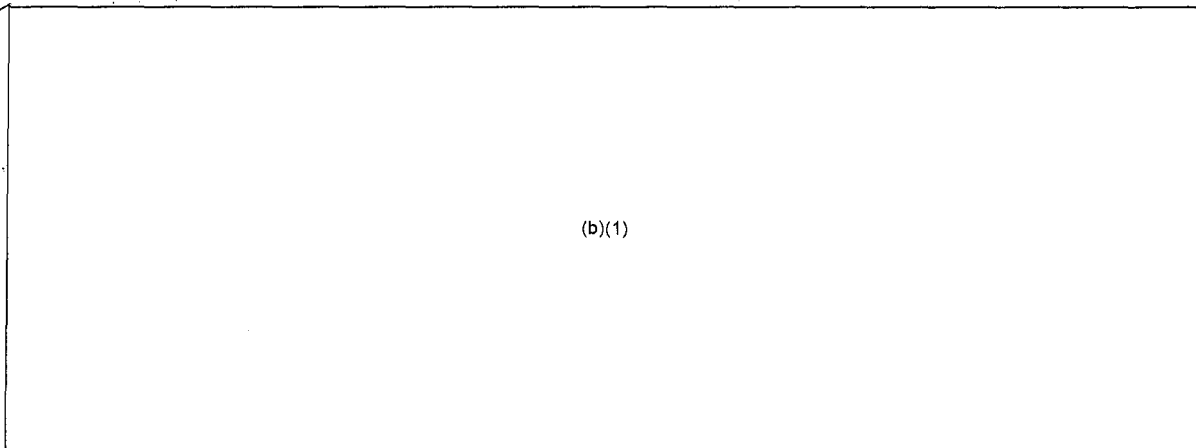

(b)(1)

~~NO FOREIGN DISSEM~~

10  
608

~~CONFIDENTIAL~~

~~CONFIDENTIAL~~

ST-CS-03-148-75

Original

(b)(1)

8. ~~(CONF)~~ Aerospace BW Operational Capabilities

(b)(1)

~~NO FOREIGN DISSEM~~

20

~~CONFIDENTIAL~~

609



~~CONFIDENTIAL~~

ST-CS-03-148-75

Original

(b)(1)

C. POLICY, STRATEGY, AND TACTICS REGARDING USE OF BW

9. ~~(C)~~ Policy a

(b)(1)

10. ~~(C)~~ Procedures

(b)(1)

~~NO FOREIGN DISSEM~~

~~CONFIDENTIAL~~

610

~~CONFIDENTIAL~~

Original

D. POLICY, STRATEGY, AND TACTICS REGARDING DEFENSE AGAINST BW

11. ~~(C)~~ Policy

(b)(1)

12. ~~(C)~~ Procedures

(b)(1)

~~NO FOREIGN DISSEM~~

~~CONFIDENTIAL~~

~~CONFIDENTIAL~~

ST-CS-03-148-75

~~Original~~

(b)(1)

E. BW MATERIEL (OFFENSIVE)

13. ~~(C)~~ Agents

(b)(1)

14. ~~(S)~~ Delivery Systems

(b)(1)

23

~~CONFIDENTIAL~~

612

~~CONFIDENTIAL~~

A ST-CS-03-148-75

Original

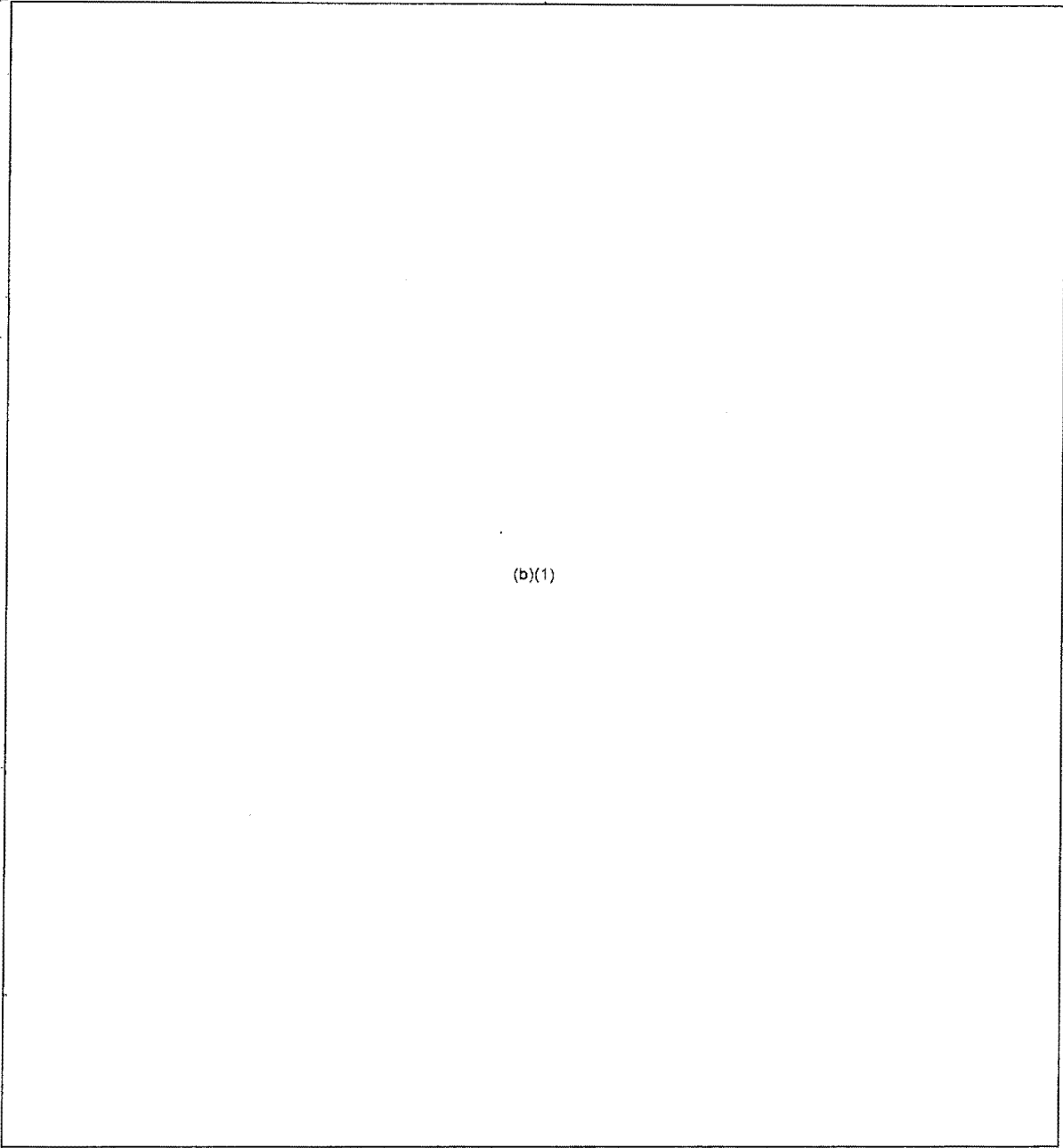

(b)(1)

~~CONFIDENTIAL~~

613

~~CONFIDENTIAL~~

ST-CS-03-148-75

Original

(b)(1)

d. (U) The Chinese have studied the transovarian transmission of *Rickettsia tsutsugamushi* by two types of *Trombicella deliensis*, which provides basic information for establishing vector colonies and their subsequent infection for possible use in a vector-agent system.<sup>67</sup> A 1966 publication urged that extensive studies of insect culture be undertaken in order to remain abreast of foreign developments.<sup>68</sup>

e. (U) The Institute of Genetics, Chinese Academy of Sciences (CAS), studies special topics in "microbacteriology" and entomology, areas of research considered the "vanguard for future bacteriological warfare."<sup>69</sup> Allegedly, discoveries in the field of bacteriology made by this institute have had profound effects on the entire mainland, but these discoveries have not been disclosed.

F. BW MATERIEL (DEFENSIVE)

15. ~~(S)~~ Decontamination

(b)(1)

<sup>67</sup>See appendix I.

~~CONFIDENTIAL~~

~~CONFIDENTIAL~~

ST-CS-03-148-75

Original

(b)(1)

16.  Detection and Identification

a. (U) There is little indication that the Chinese have conducted research to develop means of detecting and identifying biological agents. The results of some related research could be exploited for such a purpose. The Wuhan Army General Hospital obtained rapid results in identifying 55 different species of bacteria by their biochemical reactions. The time required to identify bacteria by this technique was 20 to 24 hours as opposed to 4 to 5 days by conventional means.<sup>73</sup> In 1964, an unknown author summarized a method for determining the generation time of *Bacillus anthracis*.<sup>74</sup> The following year a broth method was compared with the agar method to demonstrate the "string-of-pearls" reaction for *B. anthracis*. Details of the test were not given, but the author claimed that results were identical. Possibly the modified reaction would have contributed to more rapid identification of *B. anthracis*.<sup>75</sup> Other studies suggestive of rapid identification described experiments with incomplete antibodies for the diagnosis of brucellosis<sup>76</sup> and compared various methods for identifying *Brucella*.<sup>77</sup>

(b)(1)

~~CONFIDENTIAL~~

~~CONFIDENTIAL~~

ST-CS-03-148-75

Original

17. ~~(S)~~ Medical Protection:

(b)(1)

b. (U) Chinese military cadres are inoculated with a combined cholera and typhoid vaccine once a year. Claims have been made that all people have received vaccinations for smallpox and that the disease has been eradicated. Vaccines or antisera for typhoid, paratyphoid, typhus, diphtheria, tetanus, rabies, plague, cholera, yellow fever, and Japanese B encephalitis have been developed, but the scale of use is not known. The use of live vaccines has been exploited in China; live vaccines for brucellosis, plague, and anthrax are available.<sup>3</sup> Vaccines for the more serious animal diseases, such as swine plague, hog cholera, rinderpest, and foot-and-mouth disease, have been developed. In 1964, a method of aerosol immunization was introduced into veterinary practice. The vaccine material was sprayed or dusted into a room where animals were exposed and immunized.<sup>87</sup> Immunization of humans by the aerosol route with live vaccines of brucella, influenza, and upper respiratory infectious agents is under investigation.<sup>49</sup> Continued efforts in aerosol research could provide means for the mass immunization of the human population and of animals in the event biological agents are used.

(b)(1)

~~CONFIDENTIAL~~

ST-CS-83-148-75

~~CONFIDENTIAL~~

Original

G. PRODUCTION FACILITIES

18. ~~(S)~~ Agents and Munition.

(b)(1)

19. ~~(C)~~ Defensive Equipment.

(b)(1)

~~CONFIDENTIAL~~

617



~~CONFIDENTIAL~~

ST-CS-03-148-75

~~A~~ Original

(b)(1)

H. BW RESEARCH, DEVELOPMENT, AND TESTING

20. ~~(C)~~ General

(b)(1)

21. ~~(U)~~ ~~(C)~~ Military Facilities

a. ~~(C)~~ The China Science and Agricultural Scientific Research Institute, Hainan Island.

(b)(1)

~~CONFIDENTIAL~~

~~CONFIDENTIAL~~

ST-CS-03-148-75

Original

(b)(1)

30

~~CONFIDENTIAL~~

619

~~CONFIDENTIAL~~

ST-CS-03-148-75

Original

c. (U) The CPLA Veterinary University of China. The location of this institute and its true military affiliation cannot be verified. It could be part of the China People's University in Peking, or it might be misnamed because of incorrect translation.<sup>103</sup> An investigator reportedly associated with the University has studied the various types of *Pasteurella* isolated from 11 species of animals and fowl.<sup>104</sup> His observations of morphological, physiological, and biochemical properties indicated that there were no consistent host/bacterial specificities that could be reliably used to classify the 62 types of *Pasteurella* isolated. In general, although one strain of *Pasteurella* might attack many species of domestic animals and fowl, a single species of animal might be infected by several strains of the bacteria. All strains isolated in nature could give rise to variant types when grown in artificial media. Although this study was apparently conducted to advance veterinary immunology, the basic data concerning susceptibility of animals to this disease and the genetic selection of mutant strains could be applied to other infectious diseases.

(b)(1)

31

~~CONFIDENTIAL~~

620

~~CONFIDENTIAL~~

ST-CS-03-148-75

Original

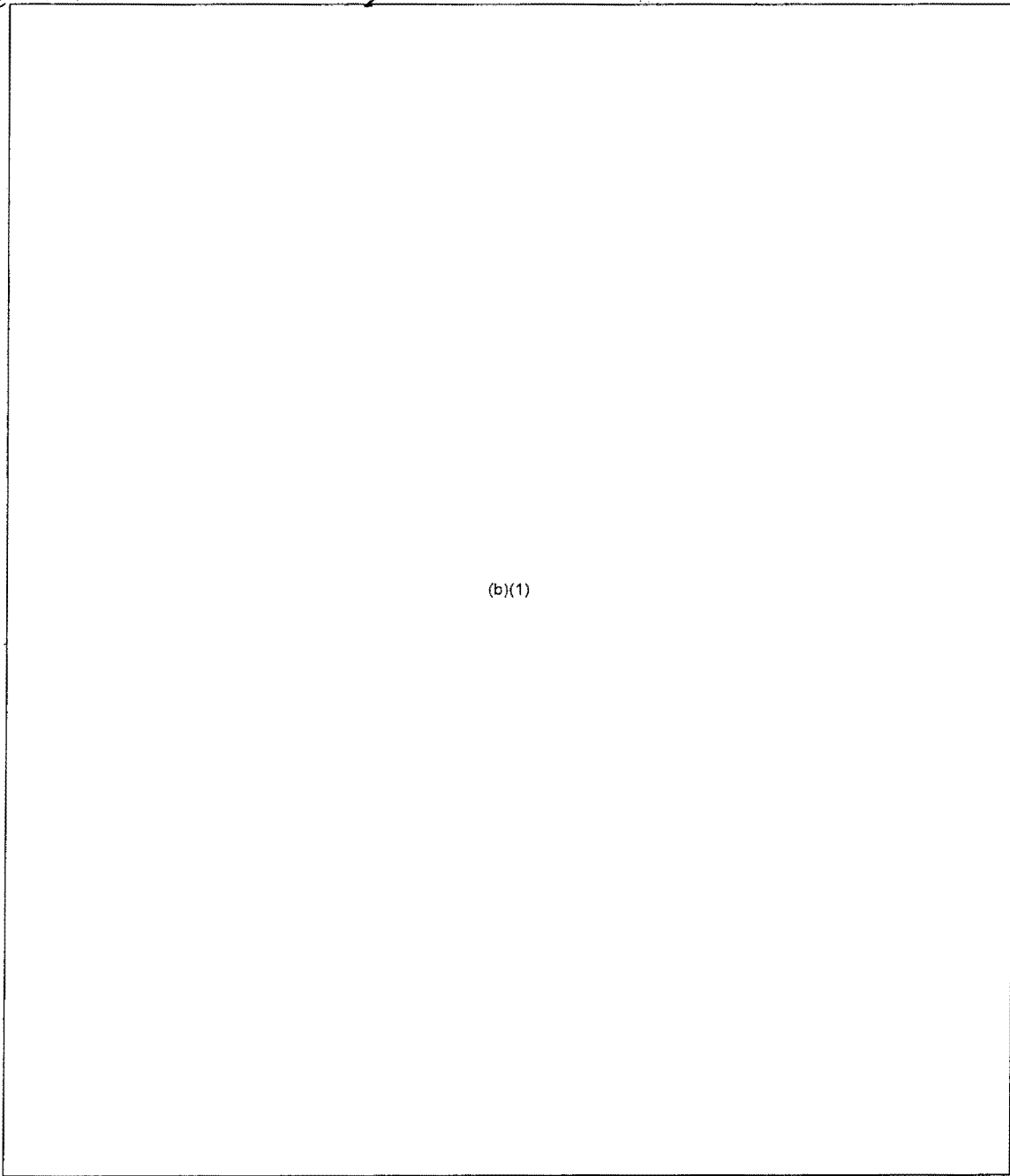

(b)(1)

~~CONFIDENTIAL~~

621

**CONFIDENTIAL**

ST-CS-03-148-75

Original

(b)(1)

33

**CONFIDENTIAL**

622

~~CONFIDENTIAL~~

ST-CS-03-148-75

Original

22.  Non-Military Facilities

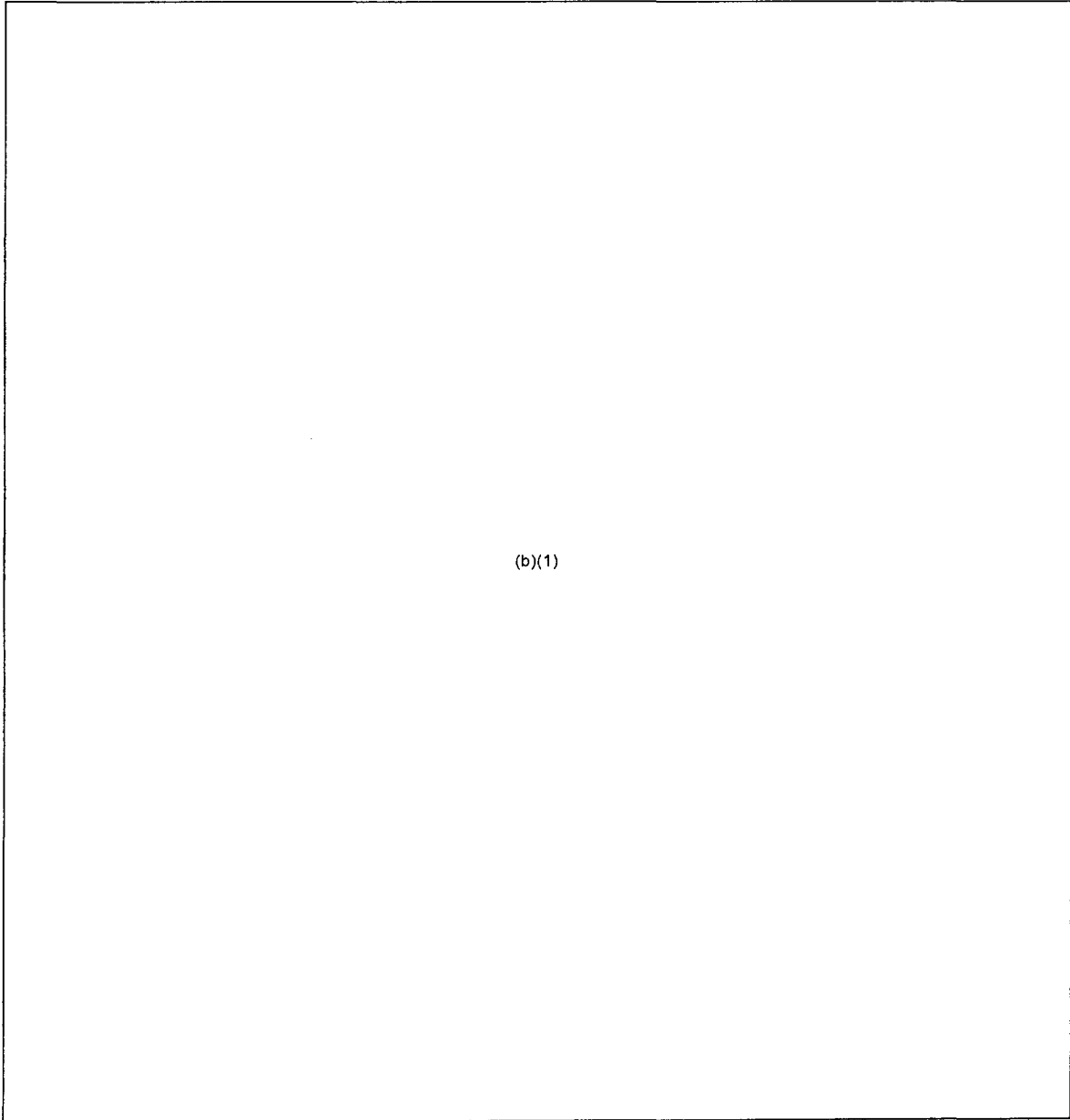

(b)(1)

34

~~CONFIDENTIAL~~

623

**CONFIDENTIAL**

ST-CS-03-148-75

*d* Original

(b)(1)

*d* (3) (U) Ch'en Po-ch'uan and others studied the infectivity of JBE virus in 1963.<sup>127</sup> They concluded that a plaque assay could be used for the routine titration of viral infectivity. A similar study, which concerned the plaque-forming characteristics of several different strains of this pathogen, was conducted.<sup>128</sup>

(b)(1)

(5) (U) Liu has published reports of his work with JBE virus.<sup>131</sup> He attempted to relate aspects of the molecular structure of the viral RNA to various biological properties

**CONFIDENTIAL**

~~CONFIDENTIAL~~

ST-CS-03-148-75

Original

possessed by the intact virus. Liu and coworkers at the Laboratory of Biochemistry of the Institute of Virology published two studies concerned with the infectious RNA of JBE virus, noting a change in RNase activity in mouse brain tissue during the course of an infection.<sup>132,133</sup> He worked on the purification of Type B infectious encephalitis virus and established the effect of pH on the maintenance of viral infectivity.<sup>134</sup> Liu later described the effect of Type B infectious encephalitis virus multiplication on xanthine oxidase activity in host tissue and also participated in several studies concerned with the influenza virus.<sup>135</sup>

(6) (U) Mao studied the effect of temperature and pH on the production of JBE virus and the effect of those parameters on interferon subsequently synthesized in chick embryo cell cultures.<sup>136</sup> The optimal temperature for virus growth was found to be 33.5°C, although interferon production increased as higher temperatures were reached. The optimal pH for interferon production ranged between 7.1 and 7.6, while the optimal pH for production of the infective virus was 7.8. These data suggest, therefore, that at pH 7.8 and at 34.5°C, the Peking strain of JBE virus would propagate to maximum titers under conditions severely inhibiting the production of interferon. The Peking strain of JBE virus is the most virulent of those known.

(7) (U) Many other investigators at this institute have contributed also to general knowledge of the JBE virus. Included are reported observations made with an electron microscope of JBE virus developing in chick embryo fibroblasts and in hamster kidney cells.<sup>137</sup> In 1960 Wang studied comparatively the growth of JBE virus in the brain and in the extracerebral nervous tissues of white mice.<sup>138,139</sup> Other studies involved the use of mice in determining the mechanism of immunization against JBE,<sup>140</sup> and the enzymatic activity and effects of ribonucleic acid (RNA) extracts of JBE on mouse brain tissue.<sup>141</sup> Much of the data obtained from these studies relative to the growth characteristics of the JBE virus would be essential to support any effort to mass produce this virus as a potential BW agent.

c. (U) Institute of Epidemiology and Microbiology, Peking.

(1) (U) This institute is subordinate to the CAMS. Research appears to be oriented toward the detection and identification of organisms causing infectious diseases, with emphasis on brucella species. Reports were published on the *in vitro* survival and multiplication of brucella in monocytic culture.<sup>142</sup> These studies were carried out primarily to explore the possibility of using a cellular reaction as a parameter of immunity against brucellosis.

(2) (U) Other work on brucella involved the agar diffusion reaction.<sup>143</sup> This interest in brucellosis and research to develop a live vaccine for aerosol immunization

36  
625

~~CONFIDENTIAL~~

(This page is UNCLASSIFIED)



~~CONFIDENTIAL~~

Original

ST-CS-03-148-75

suggest that China is not free of the consequence of this chronic disease. Attempts to resolve problems affecting public health and the practice of veterinary medicine will generate a great deal of data, some of which will be applicable to the development of brucella pathogens for BW.

(3) (U) The institute has investigated the susceptibility of human embryonic kidney and lung tissue cell cultures and monkey kidney cells to Coxsackie and Echo viruses. Monkey kidney cells were more susceptible to polio viruses, while the human kidney and lung cells were more susceptible to other viruses studied.<sup>144</sup> A new method to prepare virus-infected cells for electron microscopy was devised by placing a fine plastic tube in the center of the condenser of a light microscope. The condenser is gradually elevated until the plastic tube touches cells that have been previously fixed on a cover slip. This technique is simple and timesaving, and may allow easier selection of cell groups in their early stages of infection.<sup>145</sup> This work gives an indication of the level of expertise achieved by members of the institute.

(b)(1)

~~CONFIDENTIAL~~

~~CONFIDENTIAL~~

Original

(b)(1)

(3) (U) In 1962, studies were conducted on induced allergic encephalomyelitis in guinea pigs, albino rats, white mice, rabbits, and monkeys.<sup>153</sup> The pathological changes observed in monkeys were found to be much more complex than in the other animals, a result which might have been used as a parameter to determine similar effects in man.

(4) (U) A paper presented at the 1963 Symposium sponsored by the Microbiology Society of China<sup>154</sup> described the finding of an interferon-like substance in chick embryo cultures infected with either type B epidemic encephalitis virus or yellow fever virus. Effective inhibitory concentrations were present even after a dilution of 1:160, a fact that indicated a need to make further adjustments in concentration to reduce the plaque count to 50%. In a follow-up study (1964), JBE virus culture was investigated. The nutritional aspects of viral growth using monolayer tissue cultures were elucidated.<sup>155</sup>

(5) (U) Other notable research conducted at the institute included a study of the activation of botulinum type E toxin by trypsin.<sup>156</sup> This study confirmed the previous observations of others. Available published research on the incidence of botulism in China is scarce, and the extent of research on the toxin is not apparent. Research on botulism would probably be consonant with similar studies in other countries to combat its incidence, but might also aid any effort to develop this potential BW agent.

f. (U) Chengtu Institute of Biological Products (Chengtu Vaccine and Serum Institute), Chengtu (30-40N 104-04E).

(1) (U) Wei characterized an interferon-like substance found in the supernatant fluid of a suspension of mouse lung tissue infected with a virulent strain of *Rickettsia prowazekii*.<sup>157, 158</sup> The substance exhibited some properties quite distinct from other interferons. Wei and his coworkers were subsequently able to propagate *R. prowazekii* in monolayer cultures of embryonic mouse lung cells. From 1946 to 1951, Wei engaged in research at the Pasteur Research Institute in France. In 1952, he was a member of the Chinese Committee to Investigate Alleged US use of Bacterial Warfare in Korea.

~~CONFIDENTIAL~~

~~CONFIDENTIAL~~

ST-CS-03-148-75

Original

(2) (U) Several original studies were conducted on *Salmonella typhosa*, the causative agent of typhoid fever.<sup>159</sup> Original work also was done on isolating new subtypes of *Shigella flexneri*, the causative agent of dysentery.<sup>160</sup> Studies on the rickettsiae and on the enteric pathogens make up much of the Chinese efforts in microbiology. Work in these areas probably enjoys an emphasis second only to that given to JBE. The endemicity and epidemicity of these diseases demand that such work be performed primarily to eradicate these diseases from the environment, and to upgrade public health. The studies performed and the data gathered therefrom could be used to support related R&D efforts.

(b)(1)

h. (U) Institute of Microbiology, Wuhan. The Institute, which is subordinate to the CAS, was reportedly headed by Dr. Kao Shang-yin. Under Kao, who was educated in the United States, this institute appeared to specialize in virus research and insect tissue cell culture. At the Second Symposium of Czechoslovak Virologists, in 1958, Kao discussed two key problems in virology. The first problem addressed some basic questions concerning viral infection of cells and their altered resistance, and the second discussion concerned the application of new methods for studying viruses. Other articles gave a comprehensive outline of Chinese progress in virology, epidemiology, and immunology, as well as advances made affecting plant viruses and pest control.<sup>162-164</sup> Research has included studies descriptive of

\*The use of the genus name *Verrinus* is consistent with current taxonomic practice; however, because of past common usage and the greater familiarity of investigators with the genus name *Parasitella*, the latter term will be used throughout this report.

39

628

~~CONFIDENTIAL~~

~~CONFIDENTIAL~~

ST-CS-03-148-75

Original

morphological and structural characteristics of tobacco mosaic virus<sup>165</sup> and a virus found in the army worm.<sup>166</sup> Problems associated with the pathogenesis of typhoid fever have also been investigated.<sup>167</sup> Although virology is emphasized, competence in the general field of microbiology seems to be at an acceptable level.

(b)(1)

40

~~CONFIDENTIAL~~

629

~~CONFIDENTIAL~~

ST-CS-03-148-75

Original

j. (U) Other Institutes of Interest.

(1) (U) Investigators at the Fukien Institute of Epidemiology, Foochow, have studied the vectors of *Rickettsia tsutsugamushi*,<sup>174/175</sup> the detection of *Leptospira*,<sup>176-179</sup> and immunological methods for identifying *Coxiella burnetii*. An Infectious Diseases Hospital at Foochow and the Fukien Provincial Hospital have also been mentioned. Studies on antibiotic resistant dysentery bacilli<sup>180</sup> and the serological variability of *Shigella flexneri*<sup>181/182</sup> were conducted here.

(2) (U) Ch'en, China Medical College, studied the antibiotic resistance of a large number of strains of *Shigella*.<sup>183</sup> The Inner Mongolia Medical College, Huhekot, published results of efforts to isolate drug-resistant variants of *Shigella flexneri*.<sup>184</sup> The Institute of Antibiotics, Peking, has evaluated various nitrogen sources for growth of *Shigella* species.<sup>185</sup> and the effect of additives on growth has been determined.<sup>186</sup> These studies might have some application in a BW program, although the enteric diseases are prevalent public health problems.

23. ~~(S)~~ Potential Agent Development

a. (U) PRC investigators have studied those pathogenic microorganisms endemic in China and particularly those that cause epidemics. They have made the eradication of these diseases a primary propaganda subject, and it is evident that considerable research effort has been expended to fulfill stated objectives. Studies have been directed toward the isolation, identification, production of antigen, development of vaccines, and methods of immunization. Possible vectors of these diseases were evaluated, and artificial infection of laboratory animals by vector transmission has been studied.

(b)(1)

~~CONFIDENTIAL~~

~~CONFIDENTIAL~~

ST-CS-03-148-75

Original

Table III. Potential BW Agents (U)

*a*  
(b)(1)

~~(CONFIDENTIAL)~~

~~CONFIDENTIAL~~

~~CONFIDENTIAL~~

ST-CS-03-142-75

*a* Original

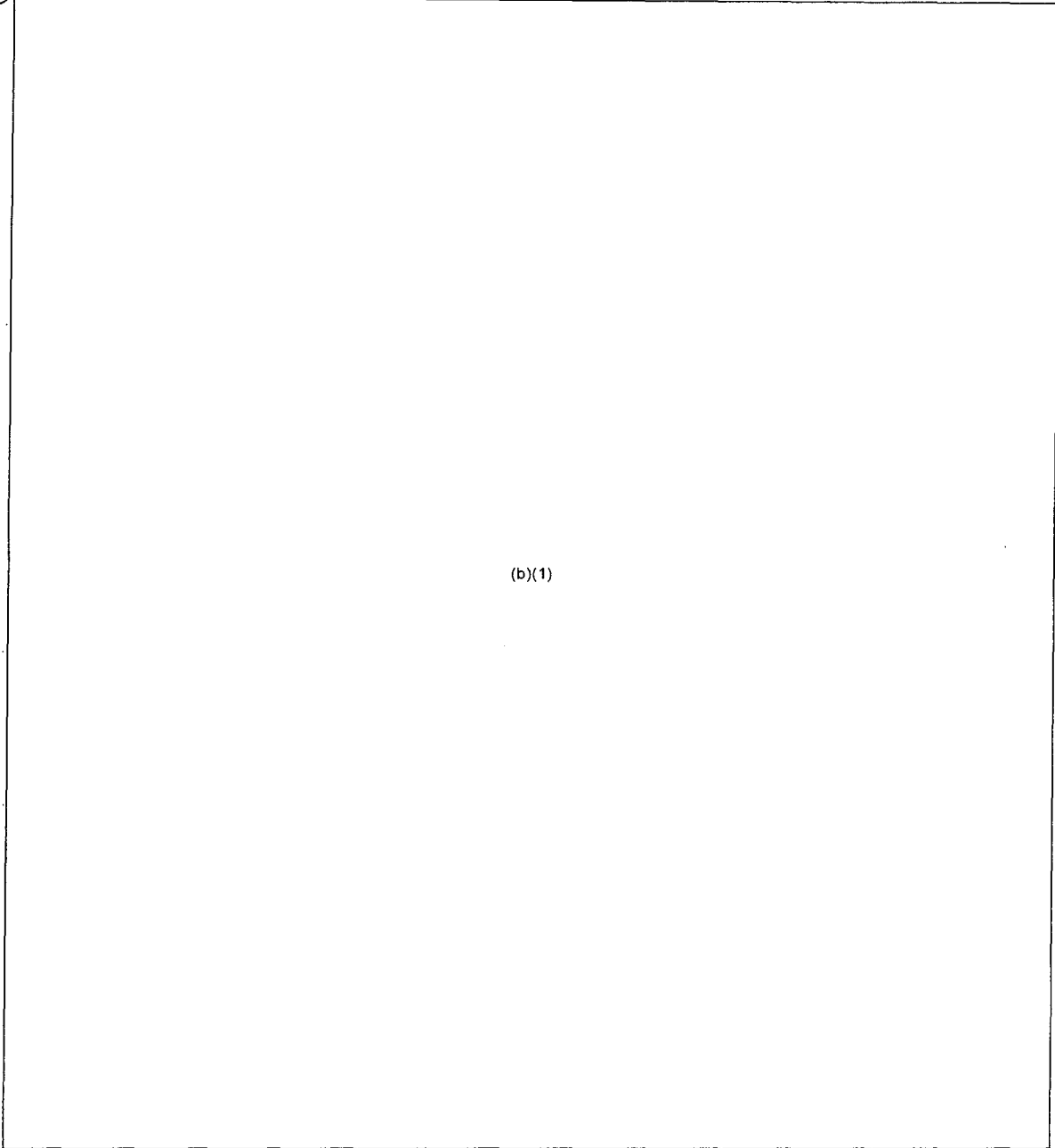

(b)(1)

43

~~CONFIDENTIAL~~

632

~~CONFIDENTIAL~~

ST-CS-03-148-75

Original

Table IV. Suspected Chinese BW Agent Production Facilities (U)

(b)(1)

<sup>1</sup>May be same as Central Biological Products Institute, which is currently the Institute for Biological Products Research.

~~CONFIDENTIAL~~



~~CONFIDENTIAL~~

ST-CS-03-148-75

Original

*c* Table IV. Suspected Chinese BW Agent Production Facilities (U) (Continued)

(b)(1)

~~(CONFIDENTIAL)~~

~~CONFIDENTIAL~~

~~CONFIDENTIAL~~

ST-CS-03-148-75

Original

(b)(1)

years.

25. (U) Biofermentation/Bioengineering as Related to BW Agent Developments

a. (U) If a successful BW program is ever to be established, fundamental data derived from R&D efforts must first be scaled-up, through process research, so that large

~~CONFIDENTIAL~~

~~CONFIDENTIAL~~

Original

ST-CS-03-148-75

volumes of precisely defined biological material ultimately can be produced at will. Unfortunately for those who are working very hard to identify this effort, equipment and facilities used for these purposes are simply not unique. For instance, processes by which biological agent pills are produced need differ only slightly from those schedules that are used to manufacture bulk volumes of vaccine material; and fermentors already in use to cultivate yeasts and actinomycetes for established commercial purposes could be adapted easily to produce pathogenic organisms with appropriate modifications for safety purposes. The facilities used for this research in China appear to be under civilian control, but presumably could be used to support military needs for the development of BW agents.

b. (U) An investigator at the Institute of Plant Physiology, CAS, spoke at the 1963 Symposium on Progress in Microbiology held at Wuhan University and pointed out that although current emphasis had been placed on developing the antibiotics industry, outstanding progress had also been made on developing biochemical engineering and industrial fermentation.<sup>191</sup> By isolating mutant strains of selected molds, by carefully determining critical parameters of their metabolism, and by modifying their nutritional requirements, notable increases in antibiotic yields had been made possible.

c. (U) At the Third All-China Scientific and Technical Conference on Antibiotics held in Dairen, September 1964, Chiang of the Institute of Antibiotics, CAMS, outlined the conditions found necessary for the optimal culture in chicken embryos of cowpox and fowl plague viruses.<sup>192</sup>

d. (U) At this same symposium, Ma of the Hua-tung Chemical Engineering College, Shanghai, noted the debt that biological engineering owed to chemical engineering.<sup>193</sup> The author forecast the continued development and greater application of biological engineering; he also stressed the need of specialized training in order to develop competent biological engineers.

e. (U) Lu, at the 20th annual symposium of the Entomology Society of China held in Peking in 1964, reviewed progress made and elucidated major problems still facing those who were interested in medical insect culture.<sup>194</sup> He noted the work on the fertilization of Chinese mosquitoes (*A. Sinenses*) by forced mating using fermented culture media to stimulate hatching; he also stressed the homogeneity of insect quality and emphasized the importance of controlling culture conditions and population densities in order to increase breeding efficiency. He urged extensive studies in order to keep abreast of foreign developments in insect culture.

f. (U) Original work was done in 1961-1962 at the Institute of Medical Biology, CMAS, Kung-ming, on the isolation of latent cytopathogenic viruses from uninoculated

47  
636

~~CONFIDENTIAL~~  
(This page is UNCLASSIFIED)

~~CONFIDENTIAL~~

ST-CS-03-148-75

Original

tissue cultures.<sup>195</sup> The viruses were not named, but data were obtained on the effects associated with regrowth of these viruses in monkey kidney cells.

g. (U) Ts'ao Chen-ch'in designed a continuous sterilizer for use in the fermentation industry.<sup>196</sup> In his report, the author evaluated various parameters related to the design, namely the time of continuous sterilization, the reaction speed constant, and the absolute temperature of sterilization.

h. (U) Another significant accomplishment has been the development of an automatic defoaming method for use in the fermentation industry.<sup>197</sup> Shen Yung-hsing described details of this development which compared in quality to the work of the Czechoslovaks, who have recently acquired equipment that controls automatically pH, foam, etc.

(b)(1)

26. ~~(C)~~ Preservation of Microorganisms as Related to BW Agent Development

a. (U) Another prerequisite for the militarization of biological materiel is an appreciation of the technology needed to stockpile agents in a viable state, so as to assure their availability for offensive use when required. The Chinese have conducted various studies that increased their knowledge of the applicable technology, mainly laboratory techniques associated with lyophilization (freeze-drying).

b. (U) In 1959, an improved method of lyophilization was described in studies from the Second Military Medical College, Shanghai, CPLA Academy of Medical Science.<sup>199</sup> Many strains of fungi and influenza viruses, together with strains of bacteria which cause anthrax, cholera, brucellosis, and plague, were maintained in a lyophilized state without loss of cultural or physiological properties. These studies demonstrated the competence of Chinese investigators to control the stability, viability, and virulence of potential agents for BW purposes.

~~CONFIDENTIAL~~

~~CONFIDENTIAL~~

ST-CS-03-148-75

Original

c. (U) The Hungshan Sanitation and Antiepidemic Experimental Institute, Wuchang, studied the survival of lyophilized *Rickettsia tsutsugamushi orientalis*.<sup>200</sup> The results indicated that the rickettsiae retained their viability up to 9 years when stored at -10° to -20°C in sucrose solutions.

d. (U) The institute for Biological Products Research, Ministry of Public Health, Peking, studied survival rates of *Vibrio cholerae* after lyophilization.<sup>201</sup> *V. cholerae* was chosen as a model because of its marked sensitivity to physical and chemical factors associated with biological decay. The investigators found that after 10 years in the lyophilized state, cholera organisms survived without significant changes in morphological, biochemical, or serological properties.

e. (U) In 1965, investigators in the laboratory of the Wuhan Municipal Contagious Disease Hospital reported on a "simple and practical way of preserving bacteria" that allowed them to keep their cultures either in a refrigerator or at room temperature.<sup>202</sup> This method was used for 3 years and proved effective.

f. (U) The Shanghai Institute of Medical Industry, Ministry of Chemical Industry, Shanghai, has also conducted studies of microbial preservation by refrigeration and disiccation.<sup>203</sup>

(b)(1)

#### I. ANTICROP RESEARCH

28. ~~(CONFIDENTIAL)~~ General #

a. (U) The PRC, the world's third largest country, with an area of 3.7 million square miles, is the world's second largest agricultural producing country after the United

~~NO FOREIGN DISSEM~~

49

~~CONFIDENTIAL~~

638

~~CONFIDENTIAL~~

ST-CS-03-148-75

Original

States. With only 7.8% of the world's cultivated area, it supports almost one-fourth of the world's population.

b. (U) This unfavorable population-land balance, which provides less than 0.4 acre of cultivated land per person, has been a major deterrent to the country's economic progress. Between 80% and 85% of the population are engaged in farming, and agriculture currently supplies one-third to one-half of the national income. Agriculture also supplies the bulk of the raw material base. Farm products and the finished agricultural products constitute 60% to 70% of total exports.

c. (U) During the first decade of Communist rule, gains in agricultural production were registered almost every year. Then 4 years of devastating reverses in agriculture, because of the reckless adventure of the Great Leap Forward (1958-60) and unfavorable weather during 1959-61, dropped farm output to a dangerously low level and resulted in a near collapse of the economy.

d. (U) Under the guise of central planning during the Great Leap Forward, officials had ignored traditional farming culture—thereby badly upsetting one of the most intricate farming systems in history. Because of the successive crop reverses, the regime beat a hasty retreat and announced a new policy of giving priority to agriculture. Since that time, gains have occurred in numerous industries designated to support agriculture.

(b)(1)

~~NO FOREIGN DISSEM~~

50

~~CONFIDENTIAL~~

639

Original

f. (U) Although exports of agricultural commodities have increased significantly since 1962, they apparently have not regained their 1959 level. Thus, a decade after the Great Leap Forward that was to solve China's economic problems within a few years, the country's agriculture is still in a state of stagnation. As one authority observed, "It may turn out that the Great Leap Forward will have cost the Chinese economy roughly a decade of growth."

29. (U) Major Crops

Rice is by far the most important crop in China. The production of rice is more than three times that of all the other major crops combined; wheat is next in acreage and production. Other principal crops are soybeans, peanuts, rapeseed, and cotton. Acreage and production figures of the major crops grown in the PRC are listed in table V.

Table V. Acreage and Production of Major Crops in the PRC (U)

Crops	Acres	Production (tons)
Rice .....		91,800,000
Wheat .....	62,114,000	22,927,000
Soybeans .....	20,433,000	8,100,000
Peanuts .....	4,339,000	2,209,000
Rapeseed .....	2,830,000	965,000
Cotton .....	10,950,000	1,241,000

(UNCLASSIFIED)

30. ~~(S)~~ R&D Against Naturally Occurring Crop Pests and Anticrop Warfare Agents &

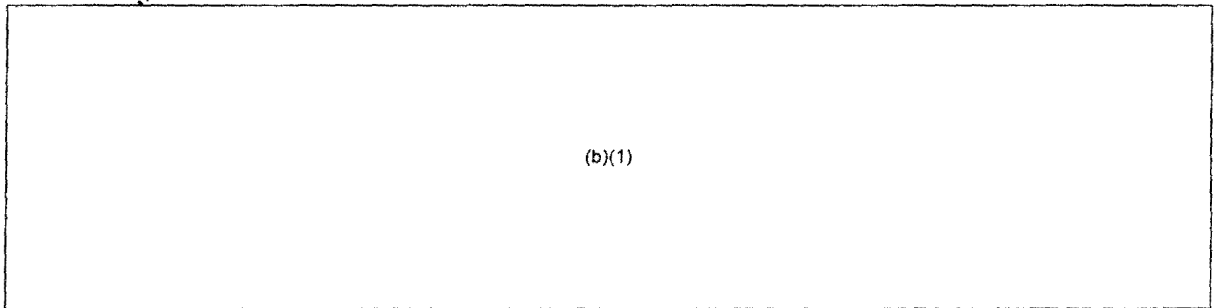

~~CONFIDENTIAL~~

ST-CS-03-148-75

Original

b. (U) Research on Rice Diseases and Insects. Since rice is the most important source of food in China, its diseases would be expected to receive the greatest attention. This opinion seems to have no basis in fact, however, since the rust diseases of wheat apparently are the object of much more research.

(1) (U) Investigations on rice diseases. Rice blast is a serious disease in China, especially in the northeast, but only one article since the beginning of 1965—concerning the application of kasugamycin, a Japanese antibiotic, for the control of rice blast—has been noted in a Chinese publication.<sup>209</sup> The study on which the article was based was conducted by a Japanese scientist. During the same time period, three papers on other rice diseases appeared:

- The Mycelial Activities of the Rice Sheath Blight Fungus in Relation to the Disease Development.<sup>210</sup>
- Studies on the Spore Dispersal of *Helminthosporium oryzae*.<sup>211</sup>
- Field Control of Bacterial Leaf Streak (*Xanthomonas oryzae*) of Rice in Kwangtung.<sup>212</sup>

(2) (U) Rice insects. The following two papers on rice insects have been noted; both concern research on the control of the paddy borer:

- Outbreak, Rhythm, and Control Technique of Paddy Borer (*Tryporyza incertellus* Walker) in Huang, Hsin, Hsi, and Demonstration Regions in Hopeh Province.<sup>213</sup>
- Forecasting the Third Generation Paddy Borer (*Tryporyza incertellus* Walker) and Chemical Control Techniques.<sup>214</sup>

c. (U) Research on Wheat Disease and Insects.

(1) (U) Races of wheat stem rust. The physiological races of the fungus causing stem rust of wheat were analyzed in 1964. Stem rust was epiphytotic in all areas of China in 1964, being generally more serious in the north than in the south. In 1964 a total of 2835 samples of stem rust spores was collected from 229 cities and districts within 26 provinces; 2006 of them have been identified. The identifications were conducted from November 1964 to March 1965 according to the usual international procedure and rules. The races and types found were: 17, 19, 21, 21C1, 21C2, 21C3, 34, 34C1, 34C2, 40, and 194. The predominance of race 21 has been gradually decreasing, whereas race 34 has been increasing in occurrence, as seen from the analyses of the physiological races found from

~~CONFIDENTIAL~~

(This page is UNCLASSIFIED)



# UNCLASSIFIED

Original

ST-CS-03-148-75

1962 to 1964. This survey was conducted by personnel from the Mukden Agricultural College, Heilungkiang Agricultural Research Institute, and the Kirin Agricultural Research Institute, all in Northeast China.<sup>215</sup> Reportedly, scientists at the Institute of Genetics of the Academy of Sciences have grown complete rice and wheat plants, directly from pollen, using tissue culture techniques. Offspring of plants initiated from pollen grains, grown in Northeast China's Heilungkiang Province and in the outskirts of Peking, apparently gave good yields.<sup>64</sup> Providing this is a practical procedure, it could revolutionize methods and drastically reduce the time required for the selection of stable, hybrid strains of plants. In addition to economic benefits realized from more rapid development of high-yields, pest- and herbicide-resistant strains of plant species, defensive anticrop warfare capabilities would be enhanced since a great variety of plant strains, each resistant to selected strains of crop diseases and crop pests, would become available.

(2) (U) Control of wheat diseases. Four effective means of stripe rust control have been developed in China: breeding of rust-resistant varieties, postponing the sowing time from 100 days to 80 days before the winter solstice, destroying disease-infested plants, and applying fungicides like sodium fluorosilicate and sulfanilamide.<sup>216</sup> According to available statistics, 6 million acres were sown with about 100 varieties of good rust-resistant strains of wheat in Shansi, Hopen, Shantung, Honan, Shensi, Kansu, and Northern Kiangsu in the autumn of 1964.<sup>217</sup> The variety Nei-hsiang 36 was reportedly immune to stripe rust but susceptible to leaf and stem rusts. A second variety, Hopen Agriculture University 3, is almost immune to stripe rust and is resistant to stem rust, while a third variety, Hsu-chou 4, is almost immune to all three types of rust.<sup>218</sup>

(3) (U) Development of chemical rust fungicides. Sulfonic acid, a systemic fungicide against wheat rust, has been tested in the field. The optimum concentration found was 6.5 to 13 pounds of 65% acid per acre. Methods for producing the acid have been developed.<sup>219,220</sup>

(4) (U) Development of antibiotic fungicides. During 1965, seven papers were published on antibiotic fungicides. All but one concerned the fungicide "Nung-K'ang-101," an isocycloheximide isolated from *Streptomyces aureus*, by the Pharmacology Institute, CAS, Shanghai. Nung-K'ang-101 was tested and found effective against wheat rust and Gibberella disease of wheat.<sup>221-227</sup>

(5) (U) Research on control of wheat insect pests. The oriental army worm, *Leucania separata* Walker, is the pest most destructive of cereal crops in Kirin Province, Northeast China. Studies have been conducted on its life history and the effects of microclimate on its population density. The wheat stem fly, *Meromyza saltatrix* Linn, is a serious pest of wheat in Shensi. Differences in varietal susceptibility have been noted: plants

# UNCLASSIFIED

ST-CS-03-148-75

Original

growing in fertile soils sustain less injury. Benzene hexachloride (BHC) or parathion provide very effective control of the adult fly. One paper describes the development of the aphid *Macrosiphum granarium*—the chief wheat pest in the province of Hsi-Nan.<sup>228-232</sup>

d. (U) Research on Soybean Diseases and Pests. Although the soybean is a major crop in China, research on its diseases and pests is sketchy. Only three papers have been noted: one on the analysis of the soybean mosaic virus, and two on the soybean pod borer. The latter is a serious pest of soybeans in Northeast China. Recommended control methods are the use of resistant varieties of soybean, proper agricultural practices, and insecticides like BHC together with DDT.<sup>233-235</sup>

e. (U) Research on Rape Disease and Pests. The Institute of Microbiology has conducted an intensive study of the rape mosaic viruses. The Chinese have identified and characterized 40 strains of the virus. A partial purification of the virus has been accomplished, and its properties have been described. Another institute has studied the epidemic relations between the vector aphid, *Myzus persicae* Salz. and the virus.<sup>236-238</sup>

f. (U) Research on Cotton Disease and Pests. Analysis of the published research papers indicates that the principal diseases and insects of cotton are: fusarium wilt, verticillium wilt, and pink bollworm. Stopping the spread of fusarium wilt and verticillium wilt appears to be the principal difficulty. Use of BHC and DDT is recommended to control the bollworm.<sup>239-241</sup>

g. (U) Insect Pest Control Research.

(1) (U) Chemosterilants. Two forestry institutes have been investigating the use of the chemosterilants to control *Dendrolimus punctatus* Walker, *Bombyx mori*, and other insects. Chemosterilants selected experimentally included Thio-TEPA, 5-fluorouracil, 5-fluorourotic acid, colchicine, nitrogen mustards, and thiocarbamide. The effects of the various chemosterilants on the different insects were described.<sup>242-245</sup>

(2) (U) Organic insecticides. Research on chemical insecticides in China appears to concern chiefly the testing of Western-developed organophosphorus and organochloro insecticides on Chinese crops. The development of synthetic processes for producing the desired insecticides for Chinese crops also is of concern.

(3) (U) Biological control. Spores of the bacteria *B. bassiana* and *B. thuringiensis* are used to control such insects as *D. punctatus* Walker, and the pine caterpillar *Grapholitha glycinivorella*, and *Cylas formicarius*. Applications of the insect fungus, *Spicaria fumoso-rosea*, have been considered for the control of a wide range of insects, including *L.*

# UNCLASSIFIED

~~CONFIDENTIAL~~

ST-CS-03-148-75

Original

*separata* Walker and *Pyrausta nubilalis* Huebner. The use of Chinese bees and the insect *Trichogramma australicum* to control the sugar cane borer has been investigated and has produced satisfactory results.<sup>246-249</sup>

(4) (U) Insect hormones. China apparently has a limited capability for controlling insect pests. Control primarily has been done with insecticides, the most common being DDT. Aware of the dangers of introducing harmful chemicals into the environment, the Chinese are seeking new methods of control. The Institute of Zoology has reported research on the sex attractant (pheromone) of pine caterpillar moths<sup>250</sup> and is attempting to identify the pheromone.<sup>251</sup> Work at the Chinese Academy of Agricultural and Forestry Sciences is directed toward the pheromones of pine caterpillar, locust, and corn borer. The pheromone of the silk-worm is being used to increase silk production. If applied at the proper time and in the right concentration, it prolongs rather than disrupts the life cycle. Larger pupae result, thus increasing silk production.<sup>207</sup> Apparently, the Chinese have not reached the field-trial stage of research, and any actual application of insect hormones to control economic pests is still some distance in the future.

(b)(1)

#### J. CONCLUSIONS

#### 32. ~~(C)~~ Offensive Posture

(b)(1)

55

~~CONFIDENTIAL~~

644

~~CONFIDENTIAL~~

ST-CS-03-148-75

Original

33. ~~(e)~~ Defensive Posture

(b)(1)

K. TRENDS AND FORECASTS

34. ~~(C-NPD)~~ Trends

(b)(1)

~~CONFIDENTIAL~~

~~CONFIDENTIAL~~

ST-CS-03-148-75

Original

(b)(1)

35. ~~(C)~~ Forecasts

(b)(1)

~~NO FOREIGN DISSEM~~

57

~~CONFIDENTIAL~~

646

~~CONFIDENTIAL~~

*e* ST-CS-03-148-75

Original

(b)(1)

*e* b. Midrange (5-10 Year Projection):

(b)(1)

~~NO FOREIGN DISSEM~~

58

~~CONFIDENTIAL~~

647

~~CONFIDENTIAL~~

ST-CS-03-148-75

~~Original~~

(b)(1)

59

~~CONFIDENTIAL~~

648

ST-CS-03-148-75

~~CONFIDENTIAL~~

Original

(This page intentionally left blank)

60

~~CONFIDENTIAL~~

(This page is UNCLASSIFIED)

649



~~CONFIDENTIAL~~

ST-CS-03-148-75

Original

Section II.

NORTH VIETNAM

A. INTRODUCTION

1. ~~(C)~~ Historical Background and Competence in Microbiology

(b)(1)

b. (U) When the Communists assumed control of North Vietnam in 1954, there was no central public health group capable of effectively instructing the people and instituting disease control procedures. Modern sanitation and public health facilities were essentially nonexistent. An MPH on the pattern of that of the PRC was established in Hanoi that year. The health organization extends down to interzonal and provincial levels, each having its own hospital or health center, along with its own medical and provincial administrators.<sup>6</sup> Little attempt was made to control scientific activities until 1958 when the State Science Committee was formed to aid the government in the organization and direction of scientific activities.<sup>7</sup> In 1960, the first attempt was made to draft a comprehensive scientific and technical program, which evidenced the attempt to plan for the orderly development of scientific effort by the State Science Committee.<sup>8</sup> The government has claimed improvement in public health and sanitation, but the number of medical personnel is inadequate, and most of them are poorly trained. After 1960, the

61

~~CONFIDENTIAL~~

650

**CONFIDENTIAL**

ST-CS-03-148-75

Original

Bacteriological Institute was made responsible for the production of vaccines against diseases of an epidemic nature. Vaccines against smallpox, tetanus, polio, and cholera have been produced, but the institute and other production facilities could not manufacture sufficient quantities to immunize all the population.<sup>9</sup> Since 1965, eastern European countries have significantly increased assistance to North Vietnam in the medical field, including construction of new hospitals and medical facilities, most of which probably serve military needs.

2. (U) Geographical and Political Factors

a. North Vietnam lies in the northeastern part of the Indochina Peninsula, bordering the Gulf of Tonkin. This relatively small and irregular-shaped country narrows from a maximum width of 375 miles in the north to about 30 miles in the south. The maximum north-south axis is about 450 miles. Its size approximates that of the state of Washington. The population of about 18.5 million is concentrated chiefly in the Red River Delta and along the coastal plains. Of the 1850 miles of land boundaries, about 800 miles border on China and about 1000 miles on Laos. Two rail routes and a number of highways connect North Vietnam with China. Two selected routes from Laos contain a road suitable for vehicular movement, but are poor access routes because of the mountainous terrain and inferior roads. The best air approaches are from the east, over the South China Sea.

b. The DRV government is a highly centralized structure paralleled by the Lao Dong (Communist Party) organization, composed of more than half a million members. Civil obedience is maintained by an elaborate police and security service backed up by the military service. The economy is tightly controlled and the people are held to an austere level of living. The position of North Vietnam in the Communist world was greatly enhanced by the personal stature of Ho Chi Minh. The Soviet Union and the PRC have each actively sought the support of the DRV in their contention for leadership in the Communist world. This has been done partly by making competitive grants of both military and economic assistance. North Vietnam, although heavily dependent on the larger and more advanced Communist countries for military and economic aid, has remained largely independent in the formulation of its domestic and foreign policies. The DRV controls its own territory through the usual Communist machinery and methods.<sup>1</sup>

c. The eleven-man Politburo of the Lao Dong (Communist) Party (LDP) is the sole decision-making body in North Vietnam. This group determines the strategy of North Vietnam's military, political, and economic affairs, and issues appropriate directives through LDP's Central Committee. The DRV's highly centralized governmental apparatus implements Politburo decisions throughout the country. LDP members hold positions at all

62  
651

**CONFIDENTIAL**

(This page is UNCLASSIFIED)

~~CONFIDENTIAL~~

ST-CS-03-148-75

Original

Bacteriological Institute was made responsible for the production of vaccines against diseases of an epidemic nature. Vaccines against smallpox, tetanus, polio, and cholera have been produced, but the institute and other production facilities could not manufacture sufficient quantities to immunize all the population.<sup>9</sup> Since 1965, eastern European countries have significantly increased assistance to North Vietnam in the medical field, including construction of new hospitals and medical facilities, most of which probably serve military needs.

2. (U) Geographical and Political Factors

a. North Vietnam lies in the northeastern part of the Indochina Peninsula, bordering the Gulf of Tonkin. This relatively small and irregular-shaped country narrows from a maximum width of 375 miles in the north to about 30 miles in the south. The maximum north-south axis is about 450 miles. Its size approximates that of the state of Washington. The population of about 18.5 million is concentrated chiefly in the Red River Delta and along the coastal plains. Of the 1850 miles of land boundaries, about 800 miles border on China and about 1000 miles on Laos. Two rail routes and a number of highways connect North Vietnam with China. Two selected routes from Laos contain a road suitable for vehicular movement, but are poor access routes because of the mountainous terrain and inferior roads. The best air approaches are from the east, over the South China Sea.

b. The DRV government is a highly centralized structure paralleled by the Lao Dong (Communist Party) organization, composed of more than half a million members. Civil obedience is maintained by an elaborate police and security service backed up by the military service. The economy is tightly controlled and the people are held to an austere level of living. The position of North Vietnam in the Communist world was greatly enhanced by the personal stature of Ho Chi Minh. The Soviet Union and the PRC have each actively sought the support of the DRV in their contention for leadership in the Communist world. This has been done partly by making competitive grants of both military and economic assistance. North Vietnam, although heavily dependent on the larger and more advanced Communist countries for military and economic aid, has remained largely independent in the formulation of its domestic and foreign policies. The DRV controls its own territory through the usual Communist machinery and methods.<sup>1</sup>

c. The eleven-man Politburo of the Lao Dong (Communist) Party (LDP) is the sole decision-making body in North Vietnam. This group determines the strategy of North Vietnam's military, political, and economic affairs, and issues appropriate directives through LDP's Central Committee. The DRV's highly centralized governmental apparatus implements Politburo decisions throughout the country. LDP members hold positions at all

62

652

~~CONFIDENTIAL~~

(This page is UNCLASSIFIED)

652

~~CONFIDENTIAL~~

ST-CS-03-148-75

Original

levels within the bureaucracy; and insure that the government functions as the party desires. The constitution was modeled extensively on the Chinese constitution and serves as an organic law for the government as well as a propaganda document for the Lao Dong. Like all Communist constitutions, it ascribes considerably more responsibility and authority to the governmental organization than exists in actual practice. The most important centers of power within the government are the executive agencies—the President of the Republic, the Premier, the Council of Ministers, and the administrative committees of the local governments. The Council of Ministers is the organization closest to the policy-making process, and the most important ministries of the Council are the Ministries of National Defense, Foreign Affairs, and Public Security. Each of these Ministries is headed by Politburo members. The Communist regime has continued to reshuffle local government organizations and generally has developed a unified, nationwide system of local administration, dominated by LDP members.<sup>1</sup>

B. ASSESSMENT

3. ~~(C)~~ Order of Battle

(b)(1)

63

~~CONFIDENTIAL~~

653

~~CONFIDENTIAL~~

ST-CC-03-148-75

Original

(b)(1)

~~CONFIDENTIAL~~

654

~~CONFIDENTIAL~~

ST-CS-03-148-75

Original

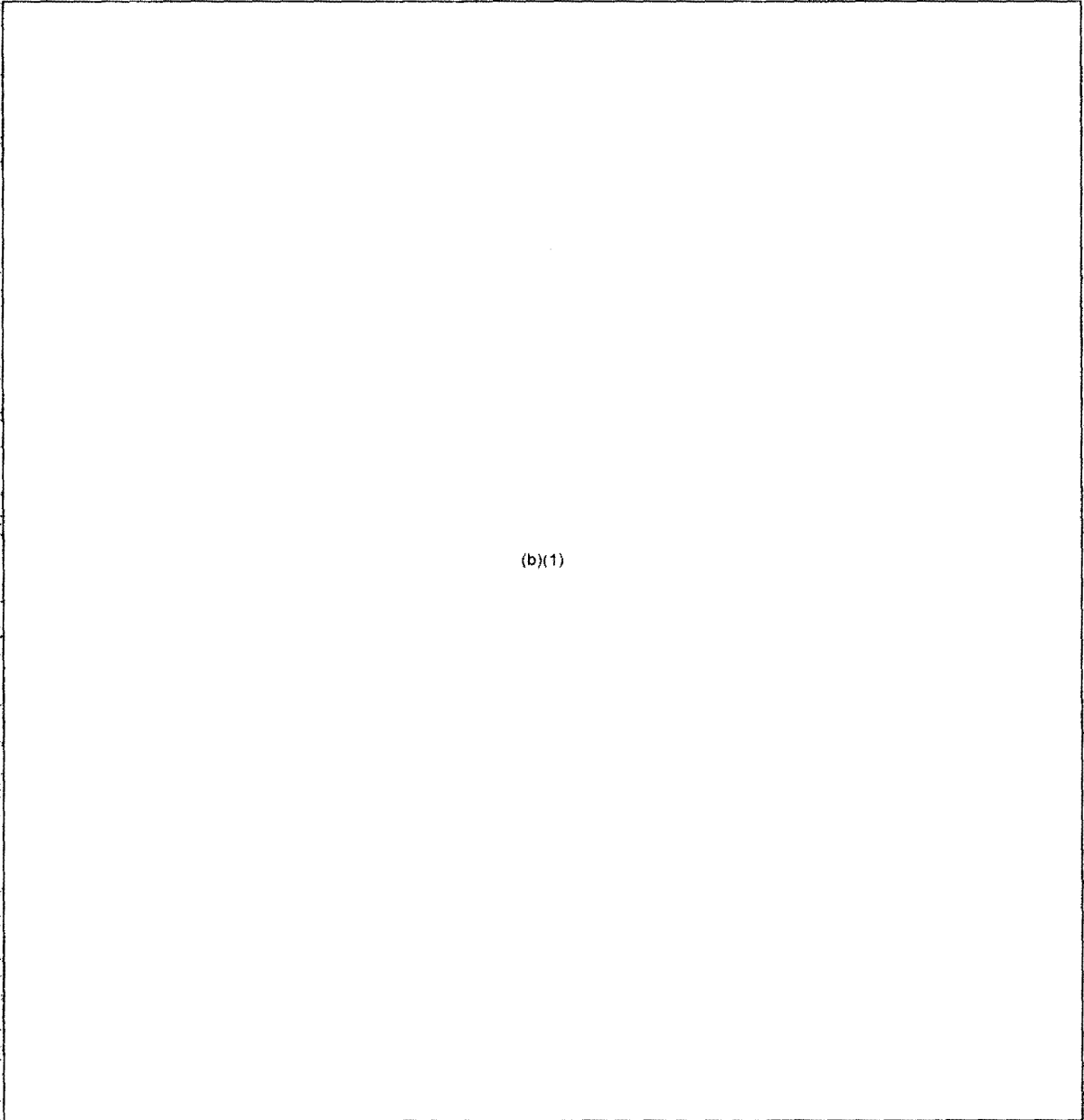

(b)(1)

65

~~CONFIDENTIAL~~

655

~~CONFIDENTIAL~~

Original

d. (U) There is no indication that the Viet Cong (VC) receive formal unit training in CBR defense as do the NVA personnel. Instruction in CBR decontamination and protection is given to the VC, and some captured training documents provide instruction for the fabrication of protective equipment. Much of the instructional material, however, is of limited practical value; it appears to be based on incomplete understanding of CBR warfare and/or to be designed for propaganda purposes.

4. ~~(S)~~ Doctrine and Procedures

(b)(1)

(b)(1)

*e* b. Defense.

(b)(1)

~~CONFIDENTIAL~~

~~CONFIDENTIAL~~

Original

ST-CS-03-148-75

(b)(1)

5. ~~(C)~~ BW Equipment

(b)(1)

- \* See appendix I.
- \*\* See appendix III.

67

~~CONFIDENTIAL~~

657



~~CONFIDENTIAL~~

ST-CS-03-148-75

Original

6. ~~(C)~~ Production and Stockpiling

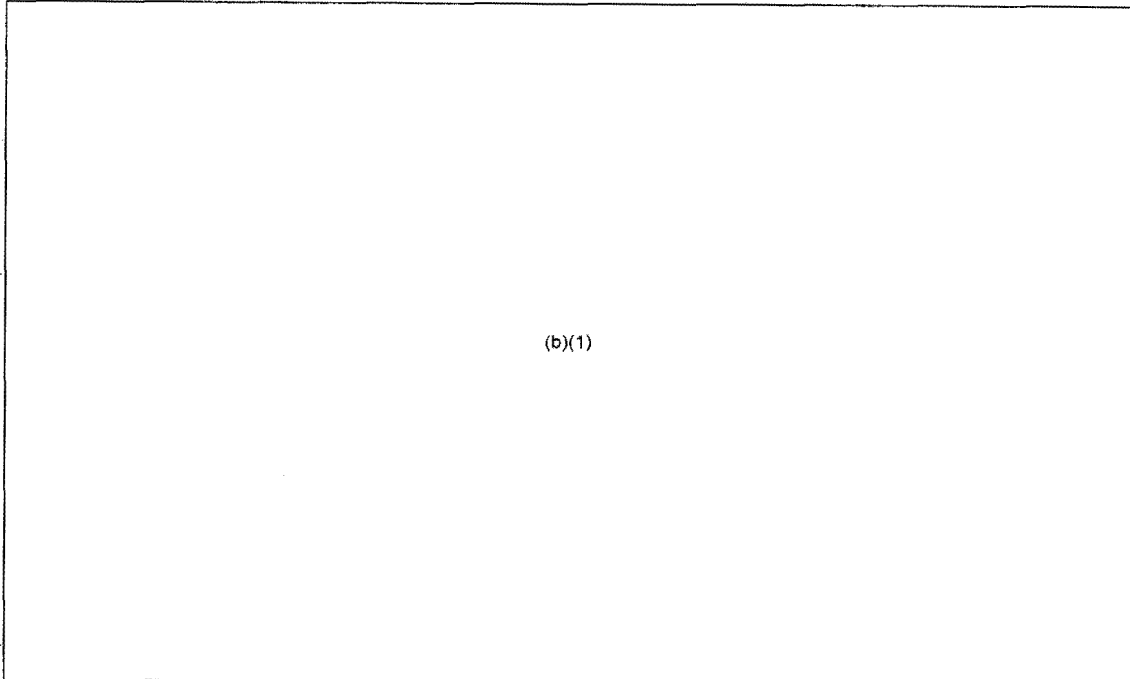

(b)(1)

7. ~~(C)~~ Research, Development, and Testing

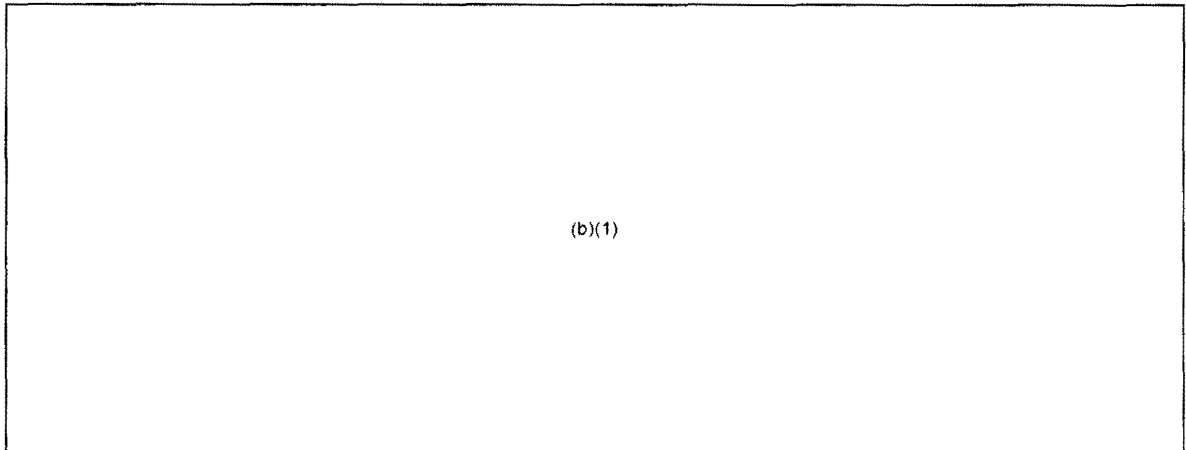

(b)(1)

68  
658

~~CONFIDENTIAL~~

~~CONFIDENTIAL~~

ST-CS-03-148-75

Original

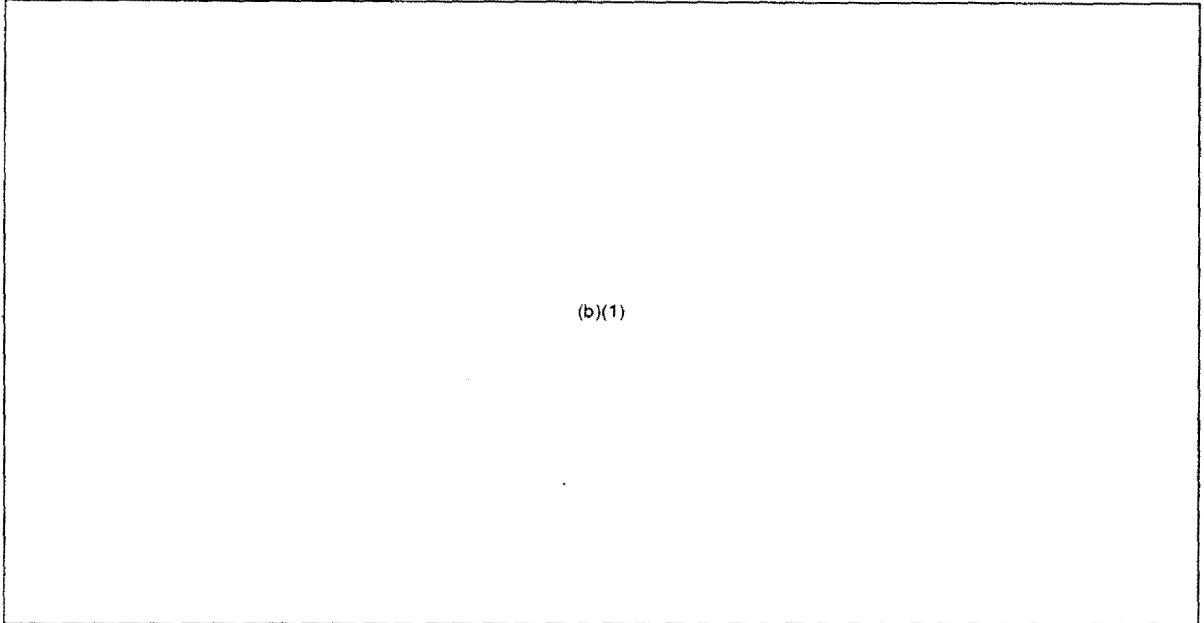

(b)(1)

d. (U) The Hygiene and Epidemiology Institute, MPH, Hanoi, was formed in 1961 to prevent and control epidemics, and to train hygiene and epidemiological workers.<sup>49</sup> Studies concerning cholera, dengue, typhoid and paratyphoid fevers, louse-borne typhus, scrub typhus, and plague have been conducted. These studies are primarily directed toward the improvement of public health conditions, but also could have an application in a BW program.

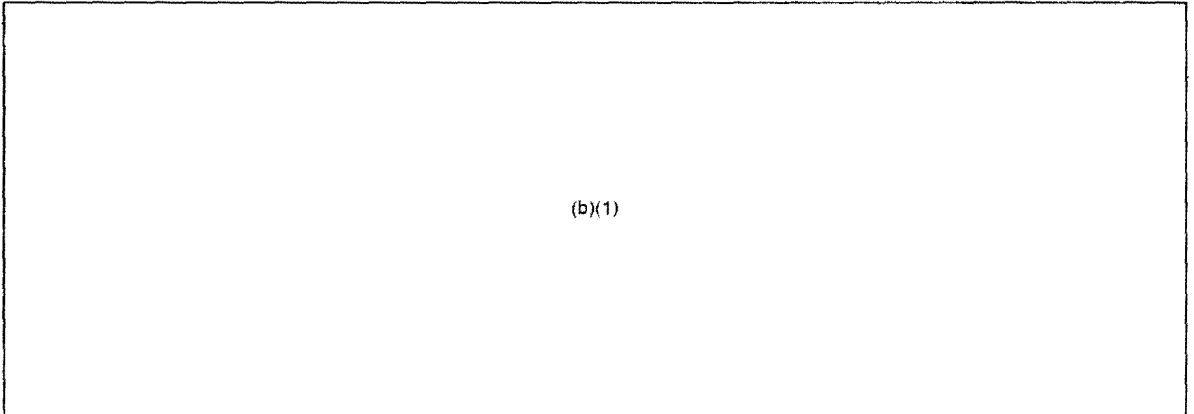

(b)(1)

69

659

~~CONFIDENTIAL~~

~~CONFIDENTIAL~~

ST-CS-03-148-75

Original

*e*

(b)(1)

8. ~~(S)~~ Conclusions

(b)(1)

9. ~~(S)~~ Trends and Forecasts

(b)(1)

70  
660

~~CONFIDENTIAL~~

~~CONFIDENTIAL~~

ST-CS-03-148-75

Original

A

(b)(1)

b. Forecasts

A

(b)(1)

71  
661

~~CONFIDENTIAL~~

ST-CS-03-148-75

~~CONFIDENTIAL~~

Original

(This page intentionally left blank)

72

662

~~CONFIDENTIAL~~

(This page is UNCLASSIFIED)

Original

~~SECRET~~  
~~CONFIDENTIAL~~

ST-CS-03-148-75

Section III.

NORTH KOREA

A. INTRODUCTION

1. ~~(S)~~ Historical Background and Competence in Microbiology

(b)(1)

(b)(1)

2. (U) Geographical and Political Factors

a. North Korea is a rugged land occupying the northern part of the Korean peninsula between the Yellow Sea on the west and the Sea of Japan on the east. It adjoins the PRC and the USSR on the north and South Korea on the south. North Korea has an area of about 47,000 square miles, approximately the size of Pennsylvania. Because of the rugged mountainous terrain, North Korea is poorly suited for ground or air operations. Pyongyang

NO FOREIGN DISSEM  
~~CONFIDENTIAL~~

73 663

~~SECRET~~

(This page is CONFIDENTIAL)

~~SECRET~~

ST-CS-03-148-75

Original

is the political, commercial, and cultural center of the country. The Hamhung-Wonsan area is the largest industrial center and includes nonferrous metal plants, chemical works, a munition plant, and an industrial machinery plant. There are also army and navy installations in the area.<sup>3</sup>

b. North Korea is a Communist Party state dominated by a closely knit clique under Premier Kim Il-sung. Occupation of the northern part of the country by the USSR in 1945 set the conditions for this political development. Initially a figurehead under Soviet direction, Kim has moved to consolidate his position by eliminating rivals and has sought to establish independence from both the USSR and the PRC. The strongest priority of the regime is directed toward the reunification of Korea. An aggressive policy of reunification was announced at a Labor Party Conference in October 1966. Subsequent propaganda campaigns were reinforced with incidents created along the demilitarized zone and terrorist attacks throughout South Korea. Another strong objective of the regime is to enhance North Korea's international position. Almost all domestic policies are integrated to establish a highly unified, self-supporting economy under state control. Some progress has been made in this effort, but North Korea has not yet attained economic and scientific self-sufficiency.<sup>3</sup> Very limited scientific effort could be diverted into a BW program.

B. ASSESSMENT

3. ~~(S-NFD)~~ Order of Battle

(b)(1)

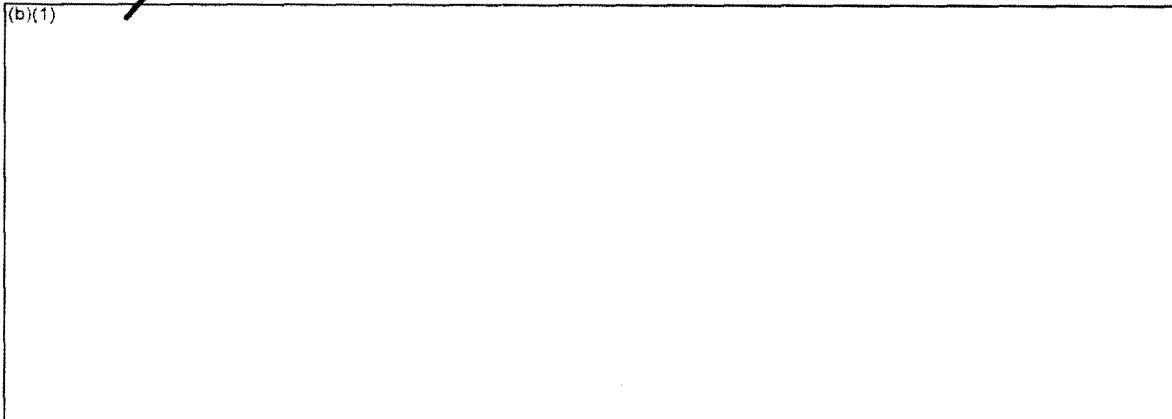

NO FOREIGN DISSEM

74  
664

~~SECRET~~

~~SECRET~~

Original

ST-CS-03-148-75

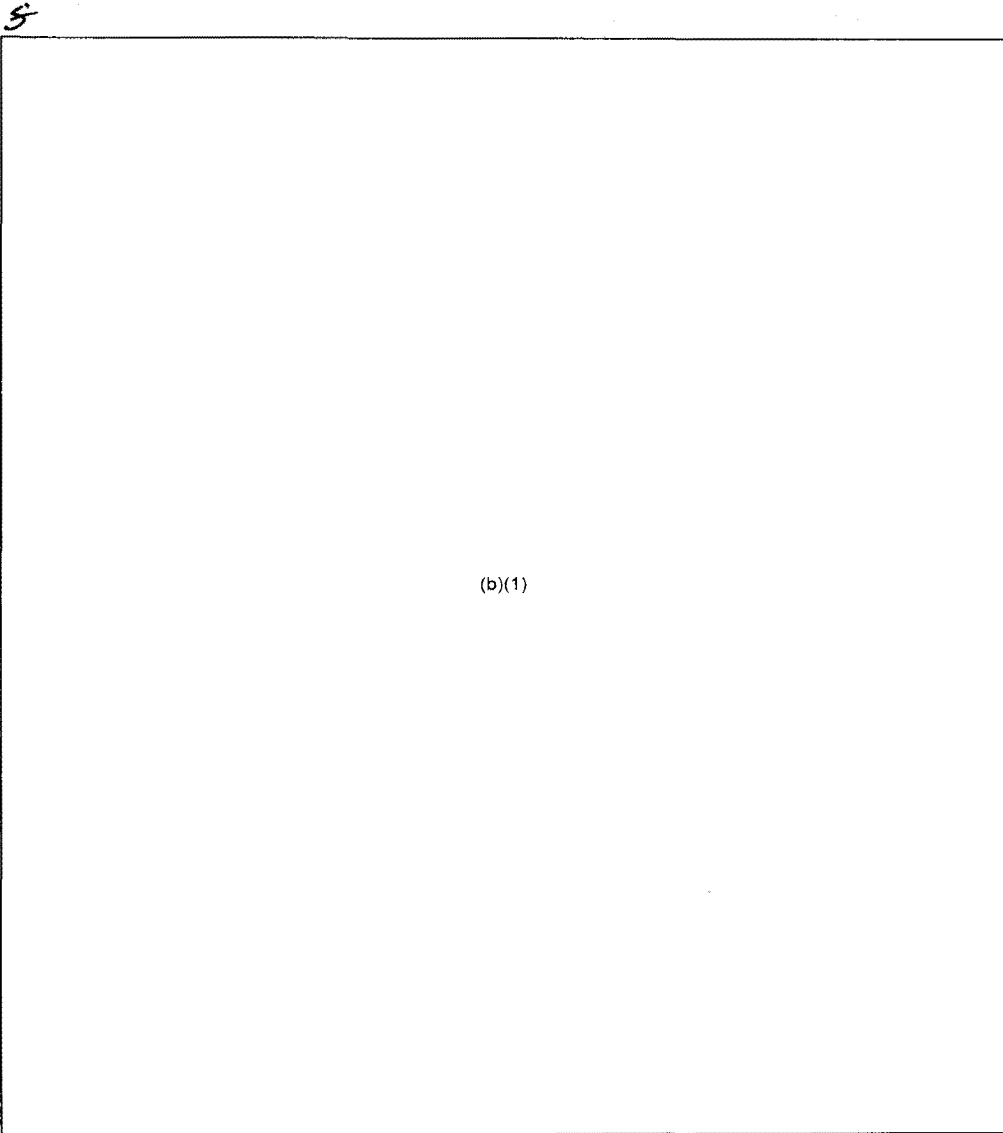

~~(SECRET)~~

Figure 12. CBR organization within the North Korean Army (U).

NO FOREIGN DISSEM

665



ST-CS-03-148-75

~~SECRET~~

~~CONFIDENTIAL~~

Original

<sup>a</sup>  
(b)(1)

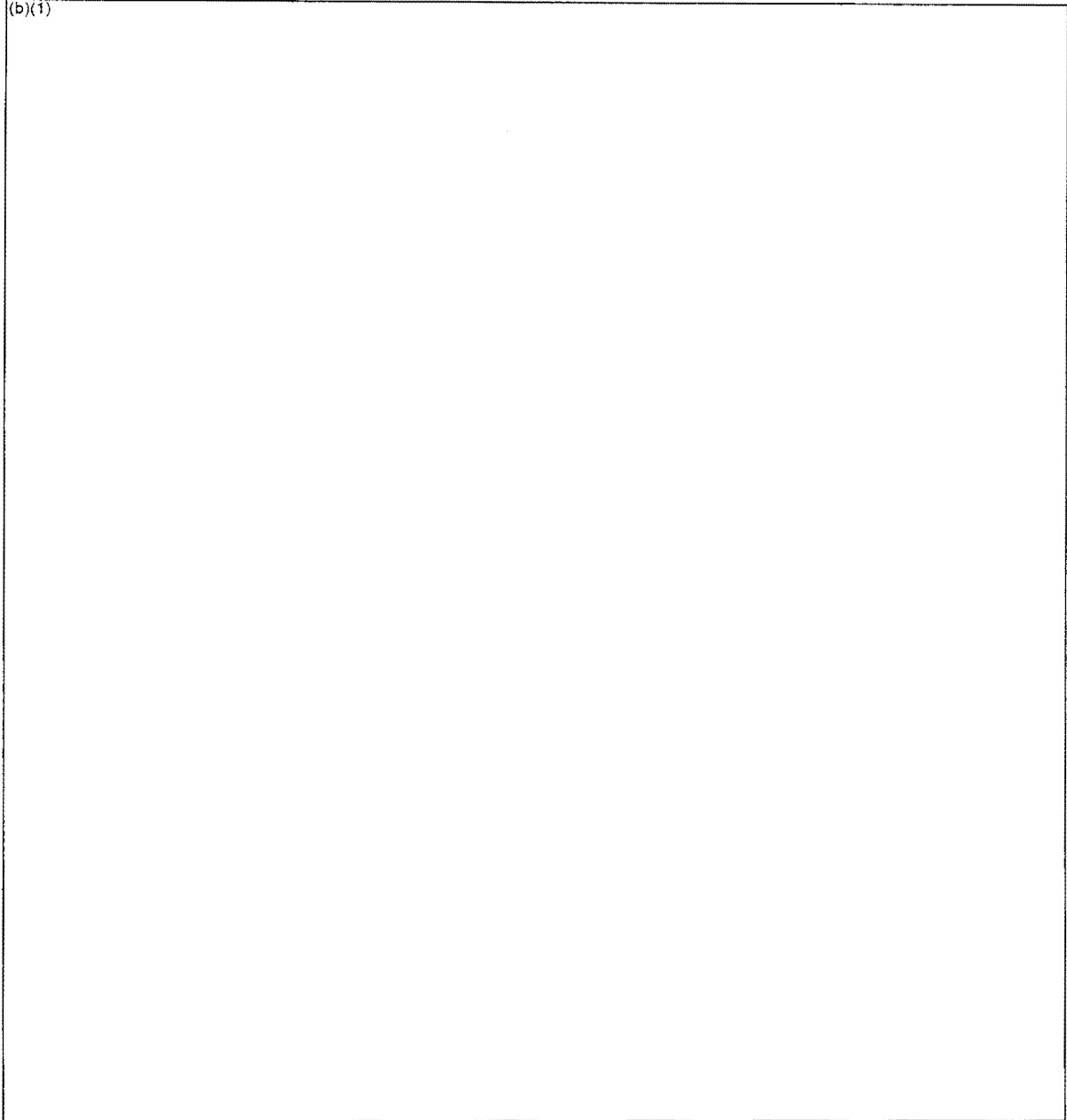

NO FOREIGN DISSEM  
~~CONFIDENTIAL~~

665

~~SECRET~~

(This page is ~~CONFIDENTIAL~~.)

Original

~~CONFIDENTIAL~~

ST-CS-03-148-75

*a* Table VI. Location of North Korean Chemical Units (U)<sup>9-9</sup>

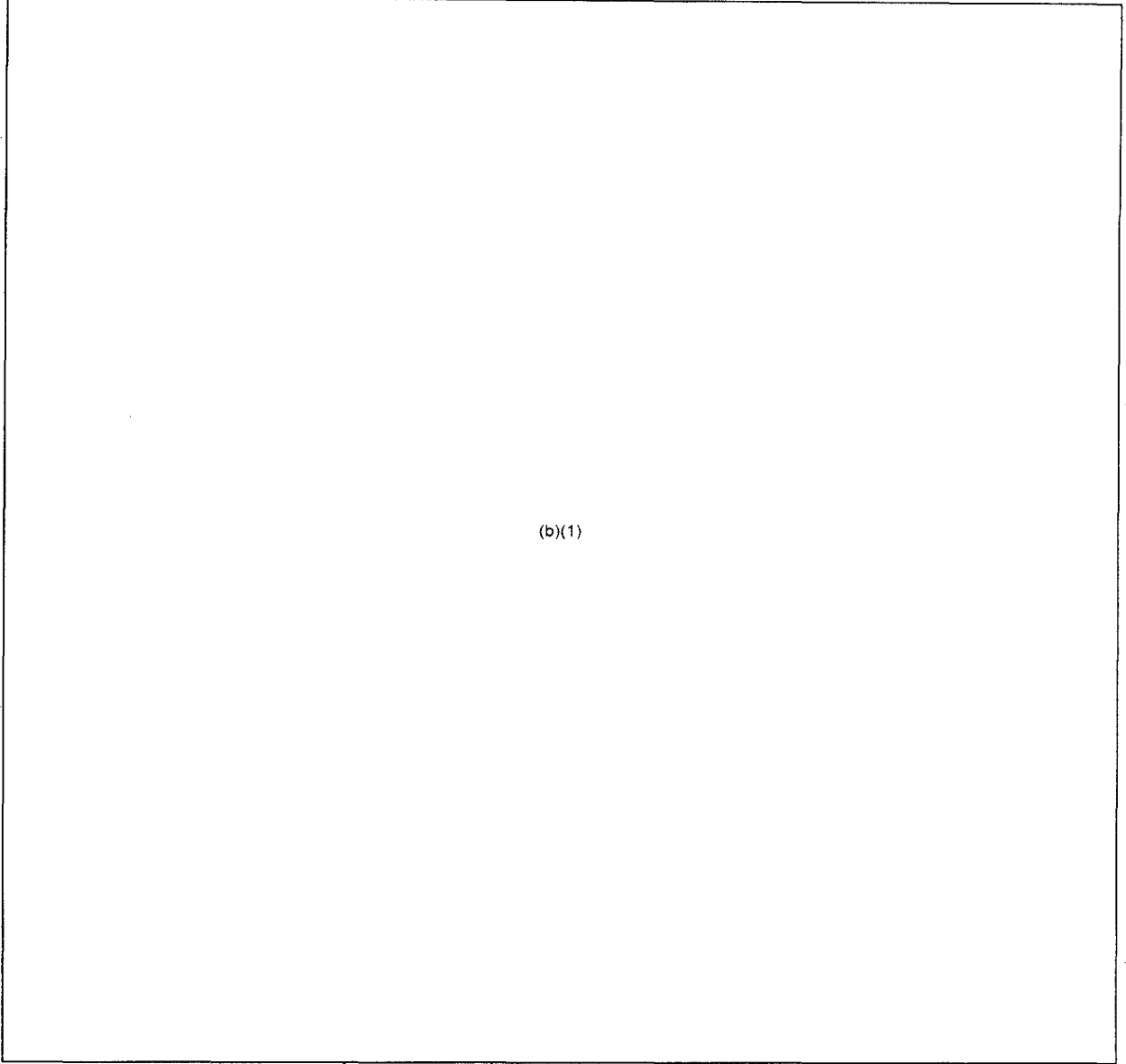

(b)(1)

NO FOREIGN DISSEM

667

77

~~CONFIDENTIAL~~

~~CONFIDENTIAL~~

Original

Table VI. Location of North Korean Chemical Units (I) (Continued)

(b)(1)

~~(CONFIDENTIAL-NFD)~~

NO FOREIGN DISSEM.

668

~~CONFIDENTIAL~~

~~CONFIDENTIAL~~

ST-CS-03-148-75

Original

(b)(1)

4. ~~(S)~~ Doctrine and Procedures

(b)(1)

NO FOREIGN DISSEM

669

~~CONFIDENTIAL~~

5. ~~(C)~~ BW Equipment

(b)(1)

6. ~~(C)~~ Production and Stockpiling

(b)(1)

- See appendix I.
- See appendix III.
- See appendix V.

NO FOREIGN DISSEM

~~CONFIDENTIAL~~

~~SECRET~~

ST-CS-03-148-75

Original

(b)(1)

7. ~~(C-NFD)~~ Naval BW Operational Capability

(b)(1)

(b)(1)

~~CONFIDENTIAL~~

NO FOREIGN DISSEM

81

671

~~SECRET~~

(This page is ~~CONFIDENTIAL~~)

~~SECRET~~

ST-CS-03-148-75

Original

4

(b)(1)

8. ~~(S/NFD)~~ Research, Development, and Testing

(b)(1)

NO FOREIGN DISSEM

82

~~SECRET~~

672

~~CONFIDENTIAL~~

ST-CS-93-148-75

Original

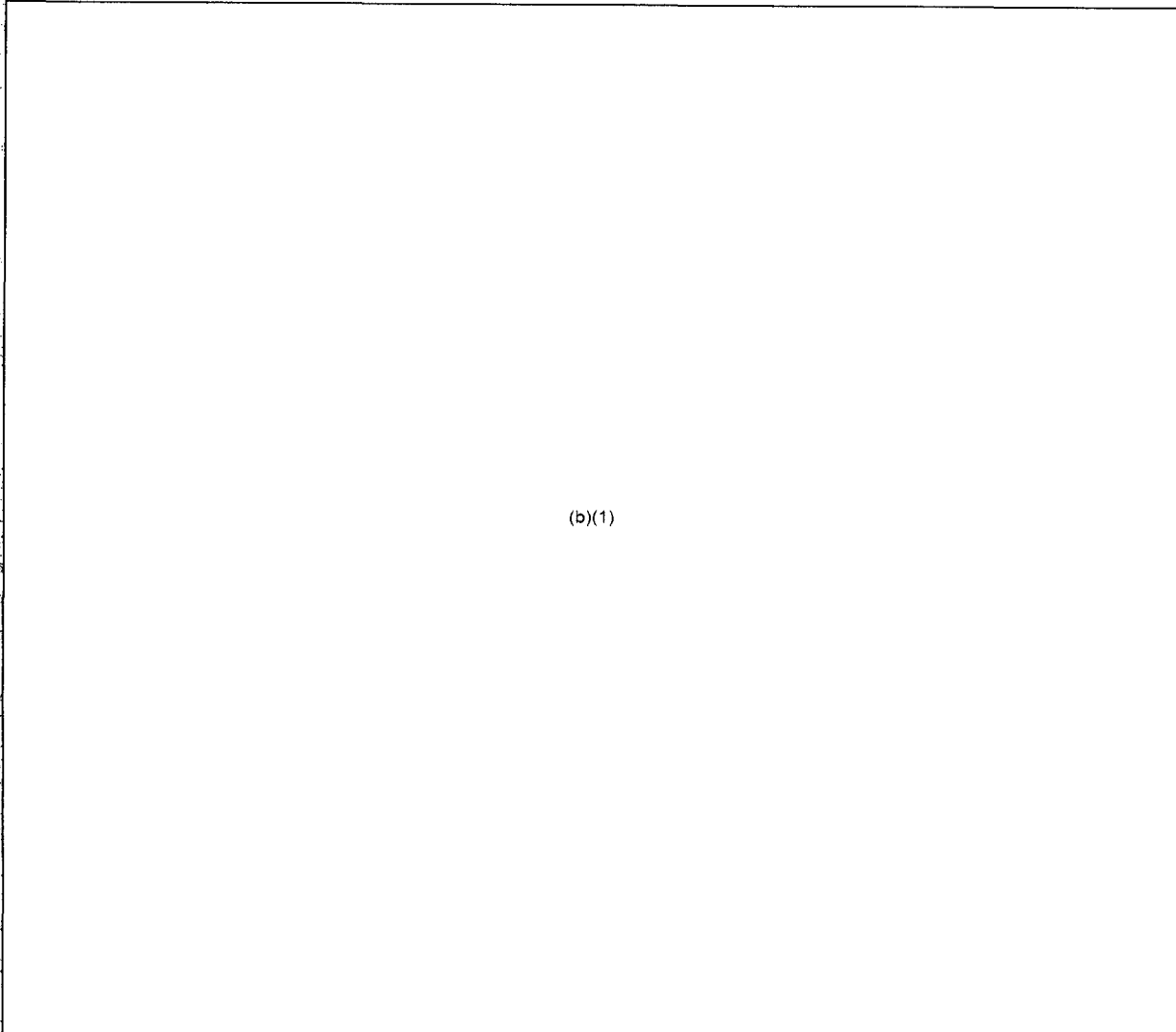

(b)(1)

9. ~~(C)~~ Conclusions

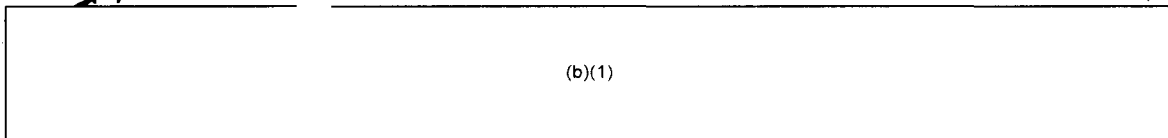

(b)(1)

83

~~CONFIDENTIAL~~

673



~~CONFIDENTIAL~~

ST-CS-03-148-75

Original

(b)(1)

10. ~~(C)~~ Trends and Forecasts

(b)(1)

~~CONFIDENTIAL~~

~~CONFIDENTIAL~~

ST-CS-03-148-75

Original

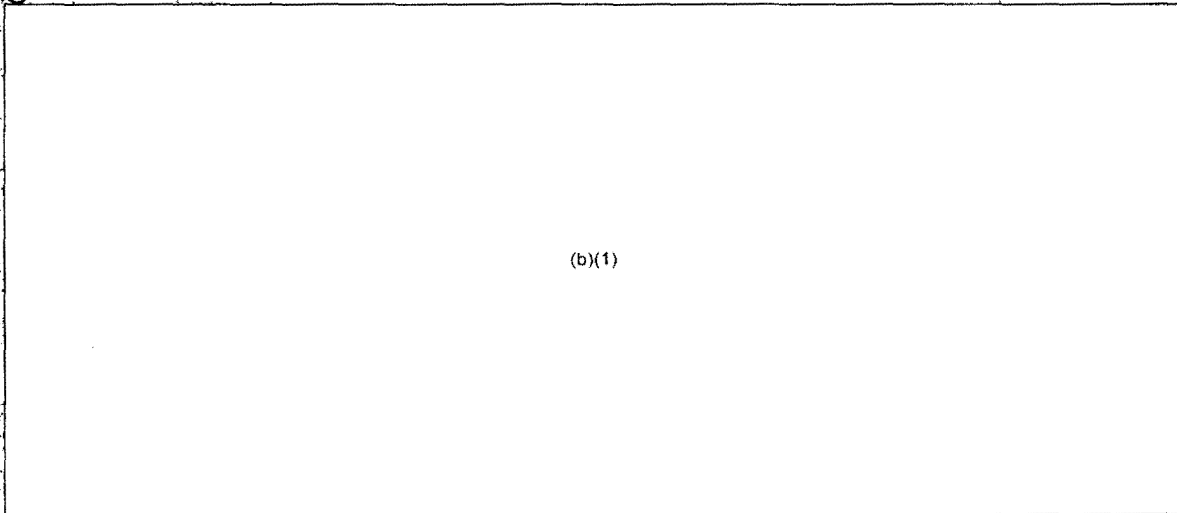

85

675

~~CONFIDENTIAL~~

ST-CS-03-148-75

~~CONFIDENTIAL~~

Original

(This page intentionally left blank)

86

676

~~CONFIDENTIAL~~

(This page is UNCLASSIFIED)

ALL INFORMATION CONTAINED HEREIN IS UNCLASSIFIED

Section IV.

THE MONGOLIAN PEOPLES REPUBLIC

---

A. INTRODUCTION

1. ~~(S)~~ Historical Background and Competence in Microbiology

a. (U) Prior to 1921, medical services in the Mongolian Peoples Republic were provided by Lamaists. In 1921, the Soviet army furnished medical aid to Mongolia's army, which resulted in the adoption of modern methods of health and sanitation throughout Mongolia. Additional advancements in public health services have occurred since the country asserted its independence in 1924. The Soviet Union has provided technical assistance in the development of health and sanitation programs and has helped to train medical personnel. Assistance is also provided by the United Nations organization and by the East European Communist countries. With this aid, the public health standards have become comparable with those in most other Asian countries.<sup>1</sup> Evidence does not show that any research in progress is associated with a BW program.

(b)(1)

(b)(1)

2. (U) Geographical and Political Factors

a. Mongolia's proximity to the Trans-Siberian Railroad in the Soviet Union and its position between the USSR and the PRC lend it a unique strategic significance. It provides

87  
677

~~CONFIDENTIAL~~

Original

road and rail routes from the USSR to the coast of the PRC. The main strategic area is Ulan Bator, the capitol city. A single-track railroad links Ulan Bator with the Trans-Siberian Railroad in Russia and extends southeast to connect with the Chinese system at Erk-lien. Of Mongolia's boundaries, 2600 miles border the PRC and 1850 miles border the Soviet Union. Since tensions arose between the USSR and the PRC, Mongolia has been used as an advanced position for the Soviet Army. Soviet units reportedly are stationed in Mongolia, and the Chinese border is constantly under observation.<sup>3</sup> Geographically, Mongolia includes vast desert plains in the south and east, long mountain ranges in the west, and hills and mountains with broad valleys in the north. The climate is continental, with great daily and seasonal extremes of temperature.

b. The Mongolian Peoples Republic is governed by a Communist dictatorship, which maintains control through a centralized system modeled on that of the USSR. The Politburo is the center of power and the source of all executive, legislative, and judicial authority in the country. Soviet influence dominates public health planning and activities in Mongolia. The USSR has provided technical assistance since 1925 in establishing a public health program, epidemiological systems, and laboratory facilities for investigating diseases. In 1931 the Soviet Union established at Ulan Bator the first antiplague laboratory, which became the Central Antiplague Station in 1936. Prophylaxis is the basic philosophy in Mongolia, and all health care and medical research units are owned and maintained by the state. The MPH is responsible for all health and medical services. The political reliability and loyalty to the Communist party often outweigh professional skill and ability in the selection of scientific administrators. For this reason, the effectiveness of the public health services and the advancement of scientific programs are often hampered.<sup>1</sup>

#### B. ASSESSMENT

#### 3. ~~(S)~~ Order of Battle:

(b)(1)

#### 4. (U) Doctrine and Procedures

The Mongolians are not known to have policies or procedures for conducting biological warfare.

~~CONFIDENTIAL~~

~~CONFIDENTIAL~~

ST-CS-03-148-75

Original

5. ~~(S)~~ BW Equipment

a. (U) The Mongolians do not have BW agents or munitions. Some vaccines, antibiotics, and sera are available for defense.

(b)(1)

6. ~~(S)~~ Production and Stockpiling

(b)(1)

7. ~~(S)~~ Research, Development, and Testing

a. (U) Mongolia's limited capability to conduct biological R&D has been directed toward an improvement of public health practices and has made possible the production of some vaccines and therapeutic compounds in country. There is no apparent interest in the development of BW agents, and efforts directed toward defense-related studies are not apparent.

b. (U) A Bacteriological Research Office was formed in 1932 by combining several small laboratories in Ulan Bator. This was the first facility under the MPH to conduct microbiological research. Diseases for which vaccines have been prepared at this facility include typhus, rabies, smallpox, dysentery, typhoid fever, and brucellosis.<sup>6</sup> A Soviet specialist, L. S. Rezininkova, assisted in directing research programs for the development of vaccines and medicines during the late fifties.

c. (U) The Office for Studying and Combating Especially Dangerous Infectious Diseases, an outgrowth of the Anti-Epidemic Office, now has five substations under its jurisdiction. It is probably the largest Mongolian organization that supports studies of measures for preventing diseases, such as anthrax, glanders, plague, poliomyelitis, and tularemia. During 1966, the organization prepared and administered vaccines to an estimated 150,000 persons.<sup>6</sup>

89  
679

~~CONFIDENTIAL~~

~~CONFIDENTIAL~~

ST-CS-03-148-75

Original

~~(c)~~

(b)(1)

8. ~~(c)~~ Conclusions

(b)(1)

9. ~~(c)~~ Trends and Forecasts

(b)(1)

90  
680

~~CONFIDENTIAL~~

~~CONFIDENTIAL~~

Original

ST-CS-03-148-75

*h*

(b)(1)

*h*  
b. Forecasts.

(b)(1)

91  
681

~~CONFIDENTIAL~~



ST-CS-03-148-75

**CONFIDENTIAL** —

Original

(This page intentionally left blank)

92

682

**CONFIDENTIAL** —

(This page is UNCLASSIFIED)

~~CONFIDENTIAL~~

ST-CS-03-148-75

Original

APPENDIX I.

FOMCAT ILLUSTRATIONS AND DESCRIPTIONS OF  
PROTECTIVE EQUIPMENT, PEOPLE'S REPUBLIC OF CHINA

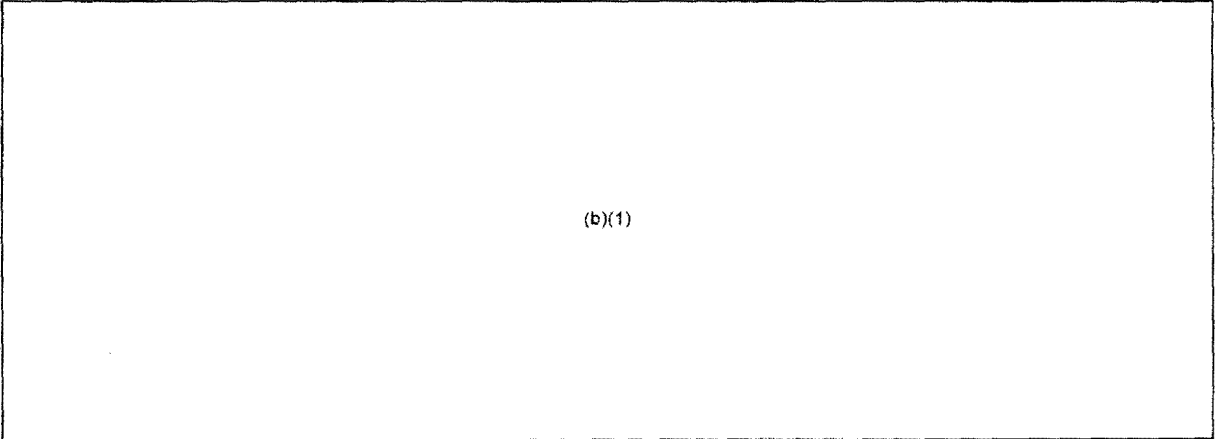

93

683

~~CONFIDENTIAL~~

ST-CS-03-148-75

~~CONFIDENTIAL~~

Original

(This page intentionally left blank)

04  
684

~~CONFIDENTIAL~~

(This page is UNCLASSIFIED)

Original  
FORM 4240-2-1-1  
NOMEN: MASK, PROTECTIVE, MODEL SMN (U) \*1

~~CONFIDENTIAL~~

ST-CS-83-148-75

ICLD 2-4240-1-11

NATIVE DES: BREW-BACKA, NN  
PRODUCED/ADOPTED: /1950

COUNTRY: USSR  
DATE UPDATED: 01AUG73

(b)(1)

(b)(1)

~~CONFIDENTIAL~~

685

ST-OS-83-148-75  
POM-4240-2-1-1

~~CONFIDENTIAL~~

Original

NOMEN: MASK, PROTECTIVE, MODEL SHM (U) \*1

(OLD 2-4240-1-1)

COUNTRY: USSR

DATE UPDATED: 01AUG73

PRODUCED/ADOPTED: /1950

(b)(1)

686

DATE CATALOGED: 01NOV69

~~96~~

~~CONFIDENTIAL~~

XGDS/2/NA

~~CONFIDENTIAL~~

ST-CS-03-148-75

Original  
FCM-4240-5-1-1

WOMEN: MASK, PROTECTIVE, MODEL PK-1 (RESPIRATOR AND GOGGLES) (U)

(OLD 5-4240-1-1)

COUNTRY: PRC  
DATE UPDATED: 23 JUL 73

(b)(1)

(b)(1)

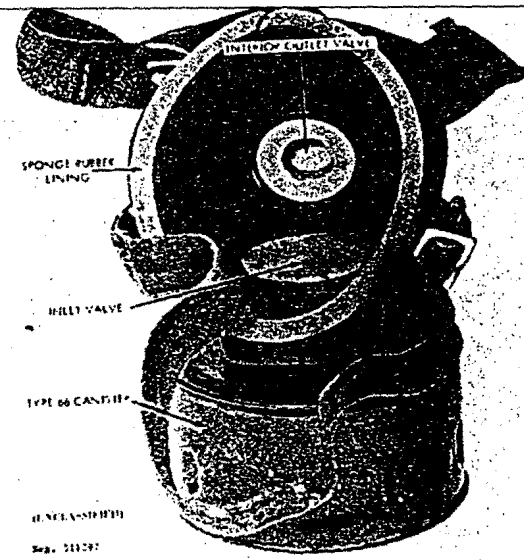

DATE CATALOGED: 01NOV69

97  
~~CONFIDENTIAL~~

XGDS/Z/NA

687

ST-CS-03-148-75  
FORM 4240-5-1-1

~~CONFIDENTIAL~~

NAME: MASK, PROTECTIVE, MODEL PK-1 (RESPIRATOR AND GOGGLES) (U)

Original  
(OLD 5-4240-1-1)  
COUNTRY: PRC  
DATE UPDATED: 23JUL73

(b)(1)

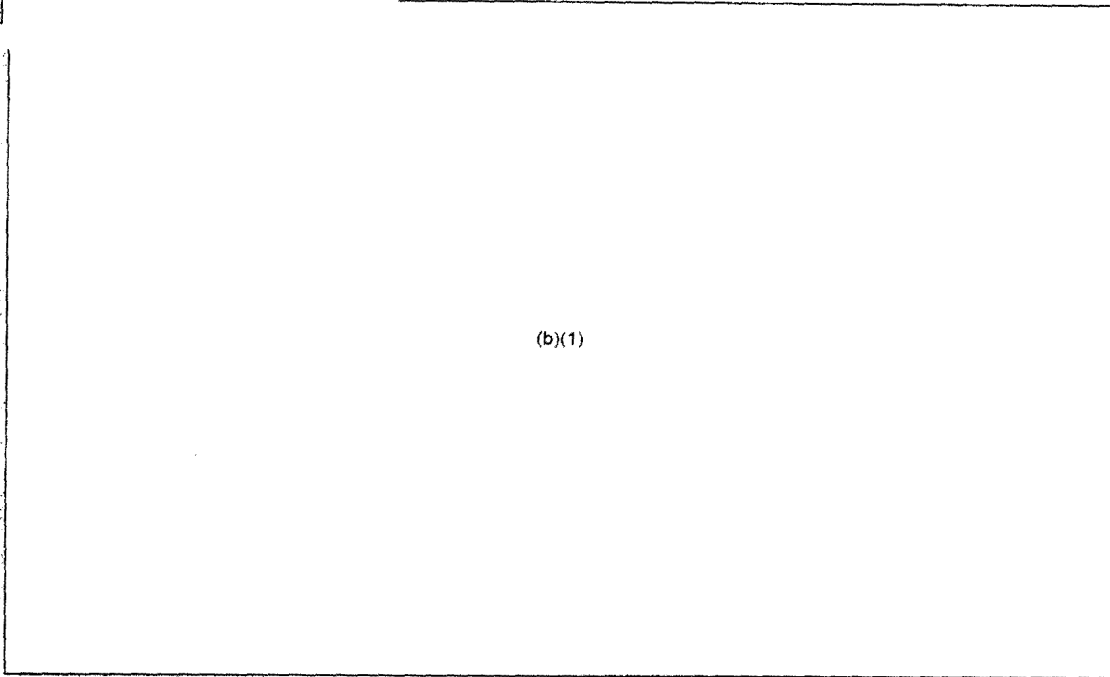

(b)(1)

REMARKS:  
1/ HEIGHT, 11.2 CM; WIDTH, 9.4 CM;  
DEPTH, 9.7 CM (APPROXIMATE)

2/ RESPIRATOR, 142 GRAMS, GOGGLES, 95.1 GRAMS

DATE CATALOGED: 01NOV69

~~CONFIDENTIAL~~

688

XGDS/2/NA

Original

FCM-4240-5-1-1

NDREN: MASK, PROTECTIVE, MODEL PK-1 (RESPIRATOR AND GOGGLES) (U)

PRODUCED/ADOPTED: /1967 7

~~CONFIDENTIAL~~

ST-CS-03-148-75

(OLD 5-4240-1-1)  
COUNTRY: PRC  
DATE UPDATED: 23JUL73

UNCLASSIFIED

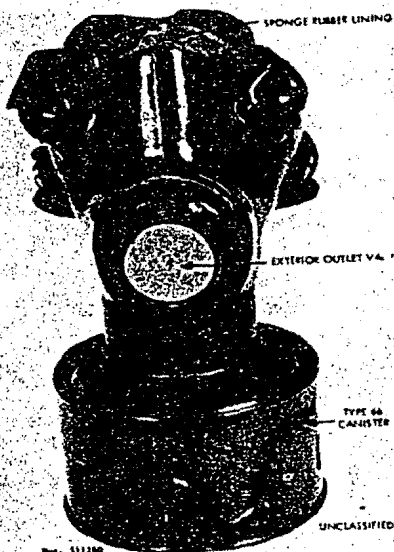
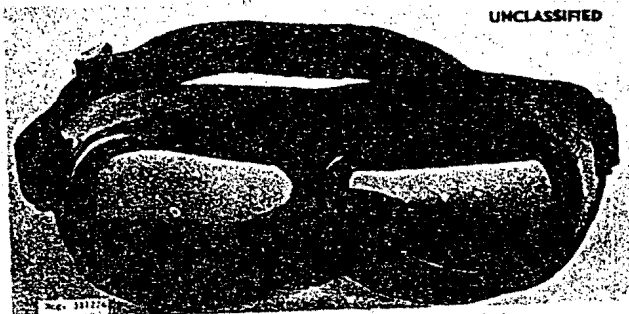

REGRADED UNCLASSIFIED  
ON 4 JAN 2011  
BY USAINSCOM FOR PA  
Auth Para 4-102 DOD 5200.1R

DATE CATALOGED: 01NOV69

98

~~CONFIDENTIAL~~

689

XGDS/2/NA



ST-CS-03-148-75

FOM-4240-5-1-1

MOMENT MASK, PROTECTIVE, MODEL PK-1 (RESPIRATOR AND GOGGLES) (U)

PRODUCED/ADOPTED: 7/1967 ?

~~C O N F I D E N T I A L~~

Original

(OLD S-4240-1-17  
COUNTRY: PKC  
DATE UPDATED: 23JUL73

DECLASSIFIED UNCLASSIFIED  
ON 4 JAN 2011  
BY USAINSCOM FOI/PA  
Auth: Para 4-102, DOD 5200.107

(This page intentionally left blank)

DATE CATALOGED: 01NOV69

100

XG05/2/NA

~~C O N F I D E N T I A L~~

690

~~CONFIDENTIAL~~

ST-CS-03-148-75

Original

FOM-8415-2-4-3

NOMENCLATURE: Suit, Protective, Lightweight, Model L-1 (U)

NATIVE DESIGNATION: ПЕГНИЙ Э АЦИТЪЯ НОСТЮМ, Л-1

COUNTRY: USSR

ADOPTED: 1955 or earlier



(b)(1)

DATE CATEGORIZED: 01SEP66

101

EGDS/3

~~CONFIDENTIAL~~

691

~~CONFIDENTIAL~~

Original

ST-CS-83-148-75

FOM-8415-2-4-3

NOMENCLATURE: Suit, Protective, Lightweight, Model L-1<sup>(U)</sup>

(b)(1)

DATE CATEGORIZED: 01SEP66

102

EDGS/3

~~CONFIDENTIAL~~

692

UNCLASSIFIED

ST-CS-03-148-75

Original

FOM-4230-2-2-1

NOMEN: DECONTAMINATION APPARATUS, MANPACK, MODEL RDP-3 (U)

(OLD 2--230-2-1)

NATIVE DES: ΠΑΝΙΕΡΜΗΙ ΤΕΓΑΝΗΘΗΘΗΜΗ ΠΡΗΠΟΡ. ΠΡΗ-3  
PRODUCED/ADOPTED: /1940 ?

COUNTRY: U.S.S.R.  
DATE UPDATED: 28AUG73

(U)THE MODEL RDP-3 IS A HAND-OPERATED, BACKPACK, SPRAY APPARATUS FOR DECONTAMINATING BUILDINGS, TERRAIN, VEHICLES, AND SUCH SMALLER OBJECTS AS PERSONAL WEAPONS. BASICALLY, THE APPARATUS CONSISTS OF A TANK WITH A LARGE FILLING APERTURE, A CLAMP-ON LID, AND SHOULDER AND WAIST STRAPS; A PISTON-TYPE AIR PUMP MOUNTED INSIDE THE TANK; AND A RUBBER DISCHARGE HOSE CONNECTED TO THE BOTTOM OF THE TANK AND EQUIPPED WITH A CUTOFF VALVE, A CONTROL VALVE, AND A NOZZLE. THE PUMP IS OPERATED BY A HANDLE THAT ROTATES A HORIZONTAL SHAFT EXTENDING THROUGH THE TANK'S FALSE BOTTOM; THE HORIZONTAL SHAFT, IN TURN, ACTIVATES A VERTICAL SHAFT THAT IS CONNECTED TO THE PUMP'S PISTON ROD.

(U)THE PUMP, BECAUSE OF ITS INTERNAL MOUNTING, IS SUBJECT TO IMMERSION IN CORROSIVE LIQUIDS, IS INACCESSIBLE FOR SERVICING, AND OCCUPIES SPACE THAT COULD OTHERWISE BE USED FOR THE DECONTAMINANT. ANOTHER SHORTCOMING OF THE RDP-3 IS THE RIGHT-HAND LOCATION OF THE PUMP HANDLE, REQUIRING USE OF THE LEFT HAND TO DIRECT THE DISCHARGE HOSE. THE MODEL RDP-4 (FOM-4230-2-2-2), WHICH SUPERSEDES THIS APPARATUS, INCORPORATES FEATURES THAT WILL ELIMINATE THESE PROBLEMS.

(U)COMPOUNDS COMMONLY USED IN THE RDP-3 ARE DICHLORAMINE-B OR -T IN DICHLORETHANE (FOR REMOVING MUSTARD AND LEWISITE FROM WOOD AND METAL), AND BLEACH SLURRY (FOR NEUTRALIZING MUSTARD AND NERVE AGENTS ON TERRAIN AND VEHICLES). BECAUSE BLEACH SLURRY CORRODES METAL, THE APPARATUS MUST BE THOROUGHLY WASHED AFTER USE WITH THIS DECONTAMINANT.

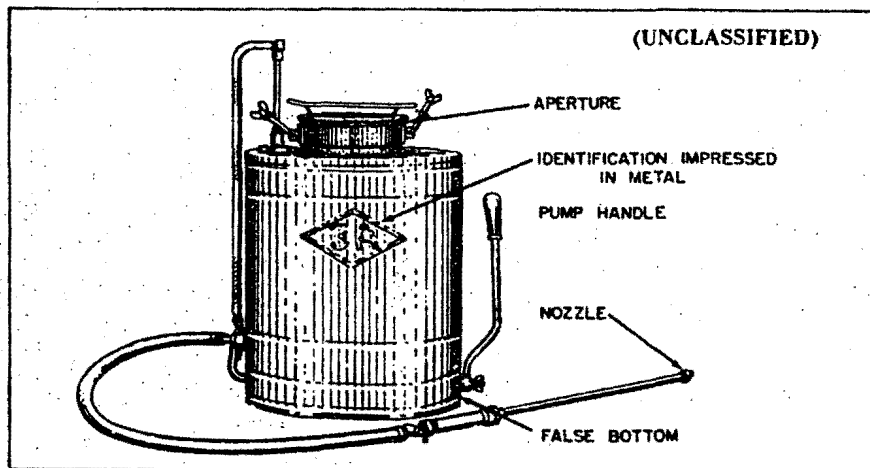

Neg. 511612

DATE CATALOGED: 01NOV69

103

UNCLASSIFIED

693

ST-CS-03-148-75

FOM-4230-2-2-1

ADEN: DECONTAMINATION APPARATUS, MANPACK, MODEL RDP-3 (U)

PRODUCED/ADOPTED: /1960 ?

CURRENT STATUS: OBSOLETE

MAJOR COMPONENTS:

TANK ----- METAL  
PUMP -----  
-POWER DRIVEN ----- N/A  
-HAND OPERATED ----- METAL  
HOSE ----- RUBBER  
STRAPS ----- WEBBING

PHYSICAL DATA:

CAPACITY -----  
-MAXIMUM ----- 12.1 LTR  
-WORKING ----- 9.5 LTR  
WEIGHT -----  
-FILLED ----- 41  
-EMPTY ----- 7.3 KG  
DIMENSIONS -----  
-LENGTH ----- 34.9 CM  
-WIDTH ----- 18 CM  
-HEIGHT ----- 40.0 CM

DECONTAMINANTS: ----- SEE TEXT

U N C L A S S I F I E D

Original

(OLD 2-4230-2-1)  
COUNTRY: U.S.S.R.  
DATE UPDATED: 28AUG73

PERFORMANCE:  
COVERAGE ----- 5.11 SQ METERS  
DISCHARGE RATE ----- 92  
DISCHARGE TIME ----- 9 MINUTES  
OPERATING PRESSURE ----- 7

PLUMBING SYSTEM: ----- SEE TEXT

GENERAL DATA:

CARRIER -----  
-TYPE ----- PERSON  
-CAPACITY ----- N/A  
CREW ----- 1  
MISC EQUIPMENT ----- N/A

REMARKS:  
1/ 20.4 KG OR LESS, DEPENDING ON THE TYPE  
OF FILLING.

2/ 0.95 LITER PER MINUTE AT 25 TO 30  
STROKES PER MINUTE

DATE CATALOGED: 01NOV69

104

U N C L A S S I F I E D

694

UNCLASSIFIED

ST-CS-03-148-75

Original  
FOM-4230-2-2-1  
MOMENT DECONTAMINATION APPARATUS, MANPACK, MODEL RDP-4V (U)  
NATIVE DES: PAKISTANI RESEARCH AND DEVELOPMENT  
PRODUCED/ADOPTED: 1968

(OLD Z-4230-2-2-1)

COUNTRY: U.S.S.R.  
DATE UPDATED: 13AUG73

(U) THE MODEL RDP-4V DECONTAMINATION APPARATUS, DESIGNED PRIMARILY FOR BACKPACK OPERATION, FEATURES AN EXTERNALLY MOUNTED HAND PUMP THAT ELIMINATES THE PROBLEMS ARISING FROM THE LOCATION OF THE PUMP IN THE MODEL RDP-3 SPRAY APPARATUS (FOM-4230-2-2-1). OTHER COMPONENTS OF THE RDP-4V ARE: (1) A TANK, WHICH HAS A LARGE FILLING APERTURE FITTED WITH A SCREWDOWN LID AND A FILTER SCREEN; (2) A FLEXIBLE HOSE THROUGH WHICH THE PUMP DELIVERS AIR TO THE TANK; (3) A SCREEN OVER THE OUTLET POINT TO REDUCE THE DANGER OF CLOGGING IN THE DISCHARGE LINE AND NOZZLE; (4) A CUTOFF VALVE ON THE DISCHARGE LINE; AND (5) A CIRCULAR SCRUBBING BRUSH THAT MAY BE FITTED TO THE NOZZLE.

(U) THE DECONTAMINANTS PRESCRIBED FOR USE IN THE RDP-4V ARE DICHLORAMINE-B OR -T IN DICHLOROETHANE, AND BLEACH SLURRY, WHICH IS CORROSIVE TO METAL AND THEREFORE REQUIRES THROUGH CLEANING OF THE COMPONENTS IMMEDIATELY AFTER THE DECONTAMINATION PROCEDURE IS CARRIED OUT.

(U) THE MODEL RDP-4V IS REPLACING THE RDP-3 AND IS STANDARD EQUIPMENT ON CERTAIN TRUCK-MOUNTED DECONTAMINATION APPARATUS. THE M-4-480 (FOM-4230-2-3-3) IS FITTED WITH SIX; THE ADM-750, AS WELL AS THE ARS-12U (FOM-4230-2-3-1), CARRIES FOUR TO SIX FOR REMOTE OPERATIONS.

(U) THE MODEL RDP-4V HAS BEEN OBSERVED IN A NUMBER OF COMMUNIST COUNTRIES. A SPECIMEN WAS CAPTURED DURING US OPERATIONS IN THE REPUBLIC OF VIETNAM IN 1969.

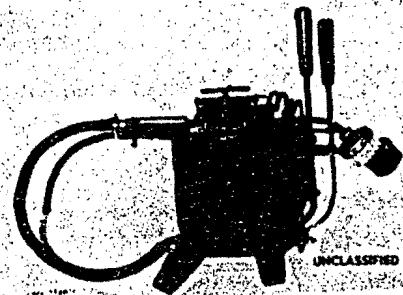
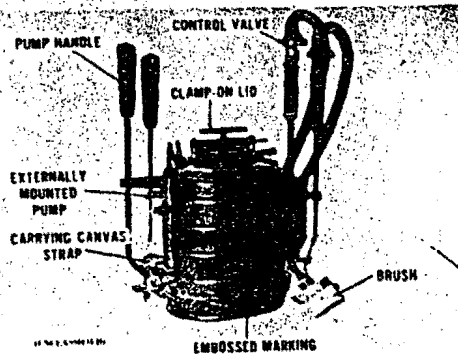

DATE CATALOGED: 01AUG69

105  
UNCLASSIFIED

695

ST-CS-03-148-75

UNCLASSIFIED

Original

FOM-4230-2-2-1

NAME: DECONTAMINATION APPARATUS, MANPACK, MODEL RDP-4V (U)

10LD Z-4230-2-2-1)  
COUNTRY: U.S.S.R.

DATE UPDATED: 13AUG73

PRODUCED/ADOPTED: /1948

CURRENT STATUS: STANDARD

PERFORMANCE:

COVERAGE ----- \*2  
DISCHARGE RATE ----- .7 TO .80 LTR PER MIN @  
25 TO 30 STROKES PER MIN  
DISCHARGE TIME ----- ?  
OPERATING PRESSURE -- ?

MAJOR COMPONENTS:

TANK ----- METAL  
PUMP  
-POWER DRIVEN ----- N/A  
-HAND OPERATED ----- METAL  
NOSE ----- RUBBER  
STRAPS ----- WEBBING

PLUMBING SYSTEM: ----- SEE TEXT

PHYSICAL DATA:

CAPACITY  
-MAXIMUM ----- 11.4 L  
-WORKING ----- 8.3 L  
WEIGHT  
-FILLED ----- 20.0 KG  
-EMPTY ----- 8.2 KG  
DIMENSIONS  
-LENGTH ----- 29.2 CM  
-WIDTH ----- 19.0 CM  
-HEIGHT ----- 36 CM

GENERAL DATA:

CARRIER ----- PERSON  
-TYPE ----- N/A  
-CAPACITY ----- 1  
CREW ----- 1  
MISC EQUIPMENT ----- SEE TEXT

DECONTAMINANTS: ----- #1

REMARKS:

1/ CW AGENTS  
MUSTARD AND LEWISITE  
(ON WOOD AND METAL)

DECONTAMINANTS  
DICHLORAMINE-B OR -T  
IN DICHLOROETHANE

2/ THE SOVIETS CLAIM THAT ONE  
FILLING WILL DECONTAMINATE 40  
RIFLES, OR 40 LIGHT MACHINEGUNS,  
OR 15 HEAVY MACHINEGUNS, OR 2  
CANNONS, OR 1 TANK.

MUSTARD AND NERVE  
AGENTS (ON TERRAIN  
AND VEHICLES)

BLEACH STURRY

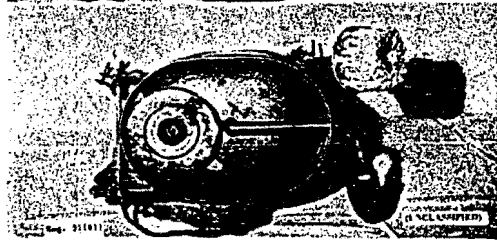
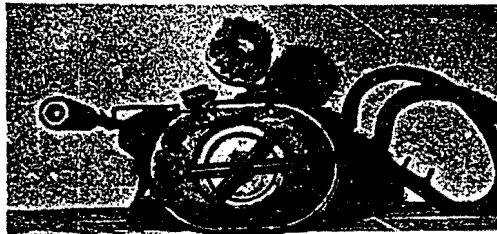

DATE CATALOGED: 01AUG69

108  
UNCLASSIFIED

696

~~CONFIDENTIAL~~

Original

ST-CS-03-148-75

APPENDIX II.

SELECTED MEDICAL MATERIEL MANUFACTURERS AND  
MEDICAL LABORATORIES, PEOPLE'S REPUBLIC OF CHINA (1971)

---

Annexes	Page
A. Manufacturers of Medical Materiel . . . . .	109
B. Medical Laboratories . . . . .	117

Classified by Cdr, USAFSTC  
Exempt from GDS of EO 11652  
Exemption Category 1, 2, 3  
Declassify on IMPDET

~~CONFIDENTIAL~~

697



~~CONFIDENTIAL~~

ST-CS-03-148-75

Original

(This page intentionally left blank)

108

~~CONFIDENTIAL~~

(This page is UNCLASSIFIED)

698

~~CONFIDENTIAL~~

Original

ST-CS-03-148-75

ANNEX A.

MANUFACTURERS OF MEDICAL MATERIEL

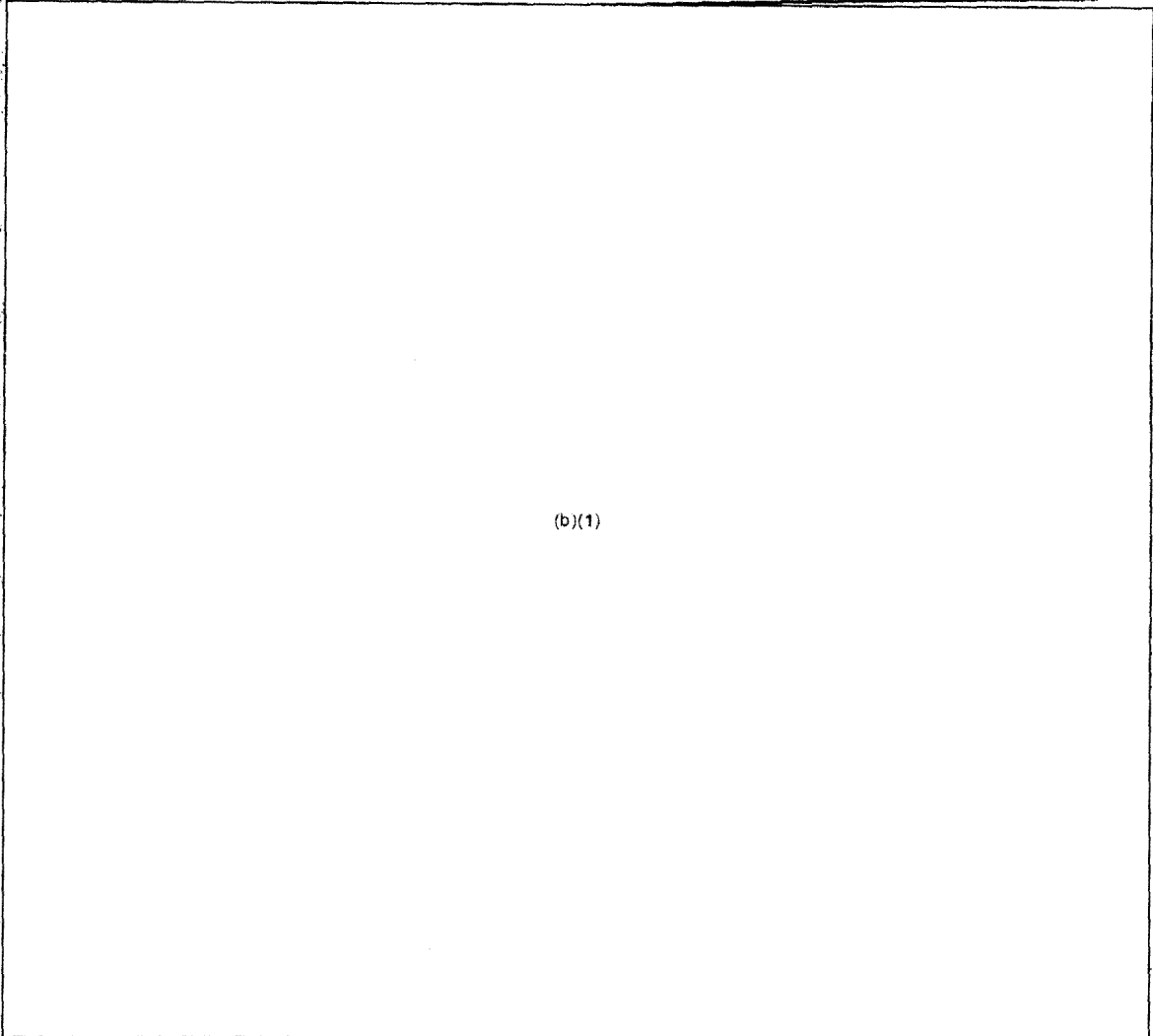

(b)(1)

Classified by Cdr, USAFSTC  
Exempt from GDS of EO 11652  
Exemption Category 1  
Declassify on IMPDET

109

~~CONFIDENTIAL~~

699

~~CONFIDENTIAL~~

ST-CS-03-148-75

Original

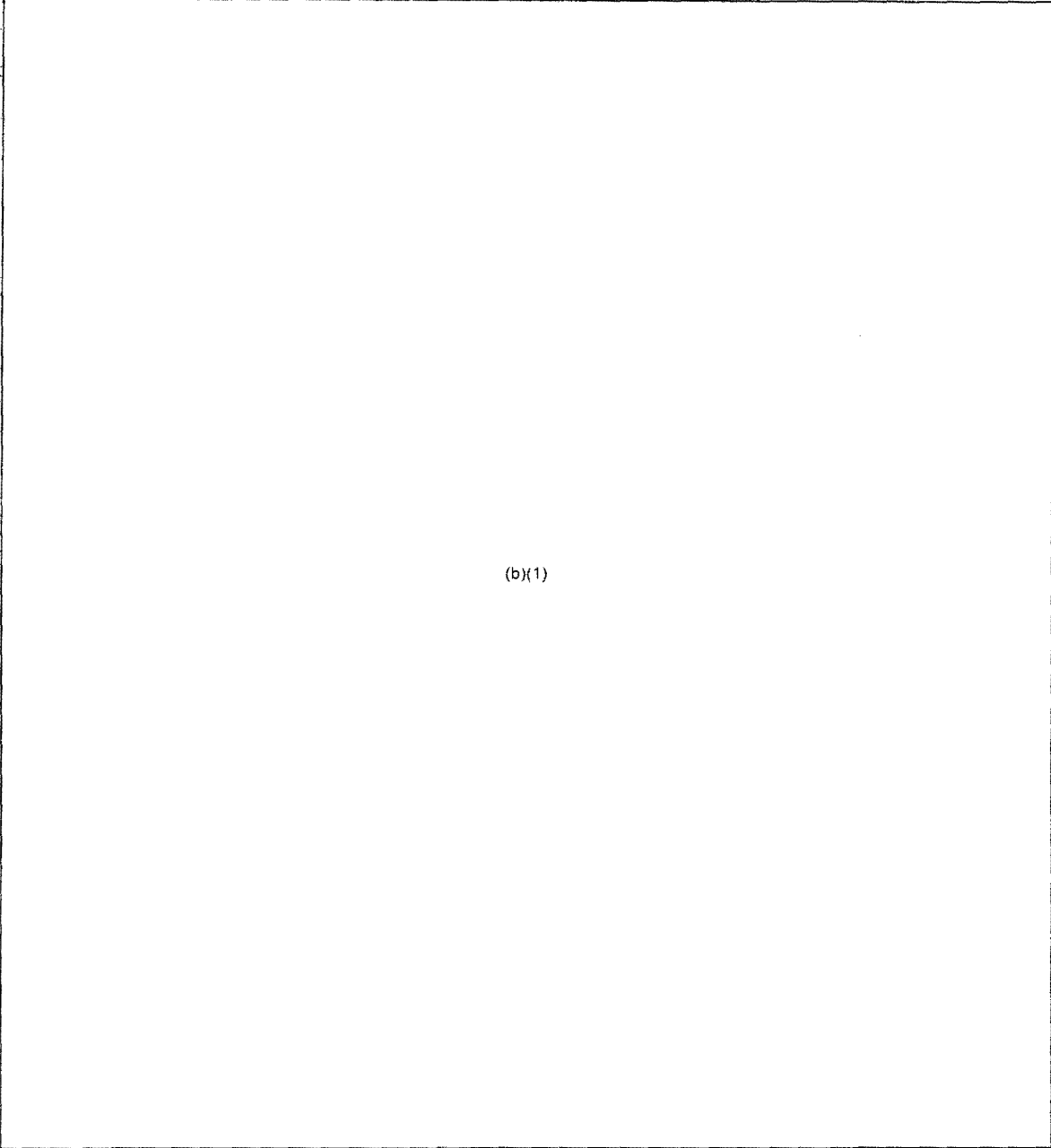

(b)(1)

110

~~CONFIDENTIAL~~

700

~~CONFIDENTIAL~~

Original

ST-CS-03-148-75

MANUFACTURERS OF MEDICAL MATERIEL (Continued)

(b)(1)

111

~~CONFIDENTIAL~~

701

ST-CS-03-148-75

~~CONFIDENTIAL~~

Original

MANUFACTURERS OF MEDICAL MATERIEL (Continued)

(b)(1)

112

702

~~CONFIDENTIAL~~

~~CONFIDENTIAL~~

Original

ST-CS-03-148-75

MANUFACTURERS OF MEDICAL MATERIEL (Continued)

(b)(1)

113

~~CONFIDENTIAL~~

703

~~CONFIDENTIAL~~

ST-CS-03-148-75

Original

*f* MANUFACTURERS OF MEDICAL MATERIEL (Continued)

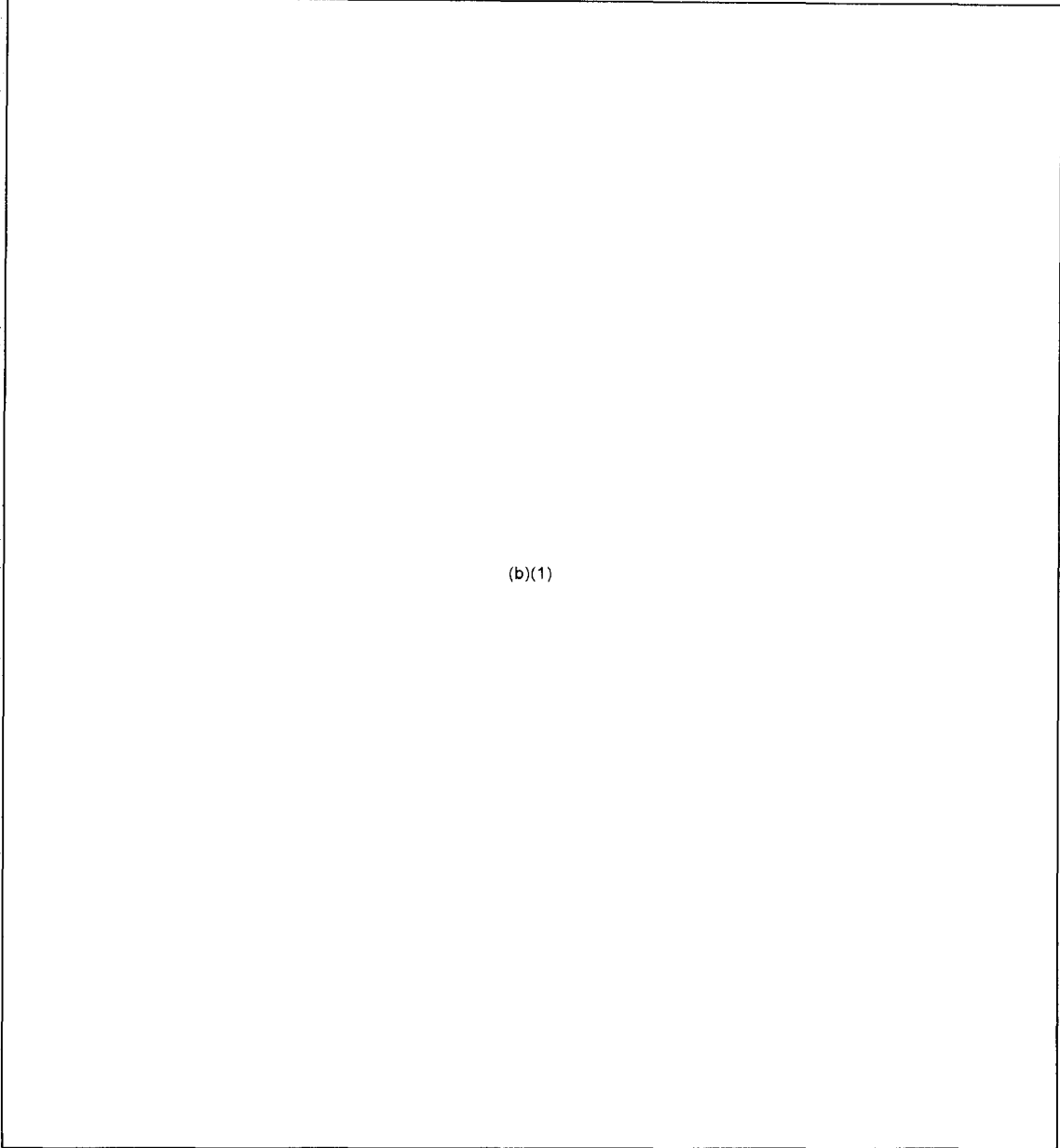

(b)(1)

~~CONFIDENTIAL~~

704

~~CONFIDENTIAL~~

Original

ST-CS-03-148-75

MANUFACTURERS OF MEDICAL MATERIEL (Continued)

(b)(1)

115

~~CONFIDENTIAL~~

705



ST-CS-03-148-75

~~CONFIDENTIAL~~

Original

MANUFACTURERS OF MEDICAL MATERIEL (Continued)

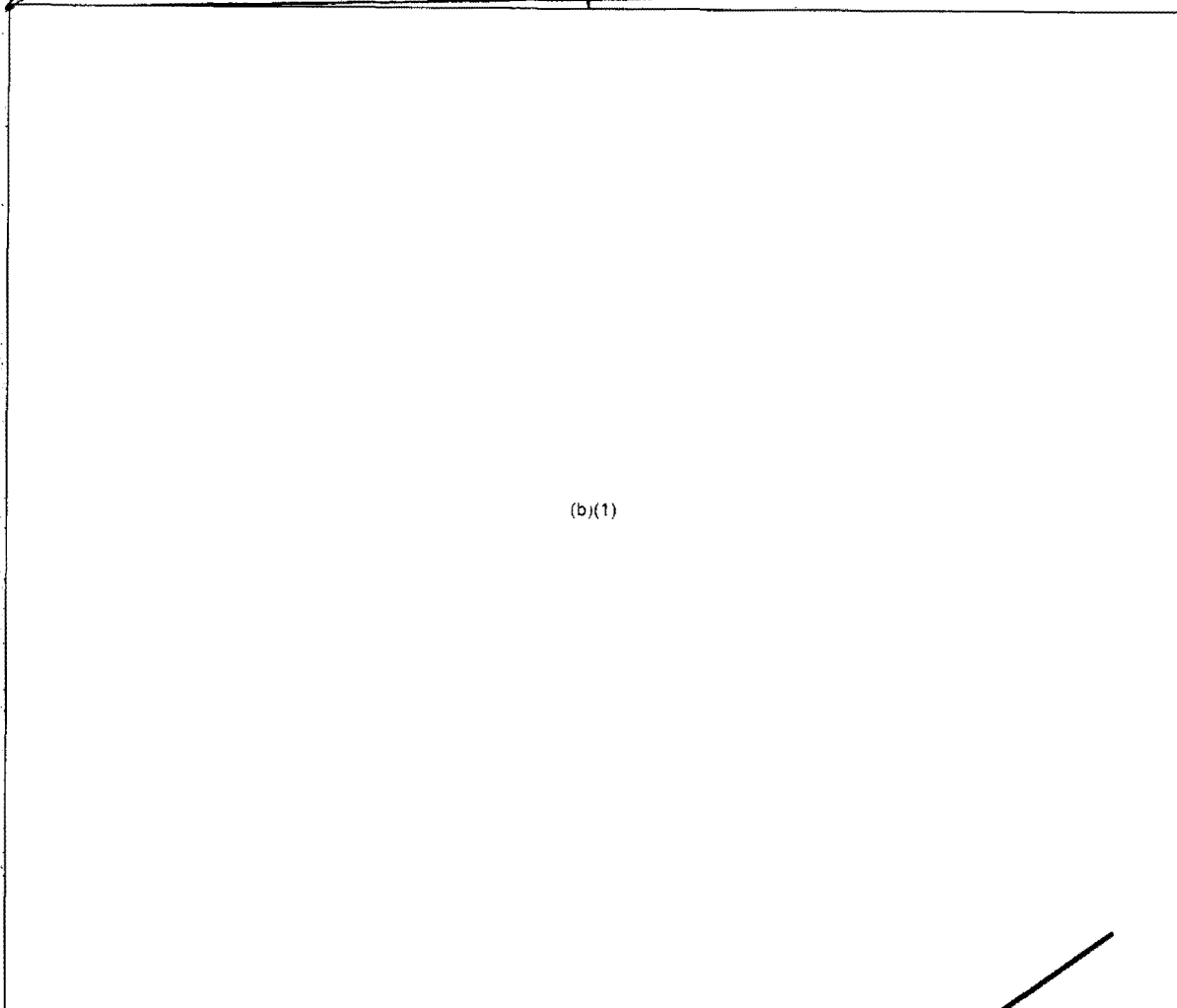

(b)(1)

~~(CONFIDENTIAL)~~

116

~~CONFIDENTIAL~~

706

~~CONFIDENTIAL~~

Original

ST-CS-03-148-75

ANNEX B.  
MEDICAL LABORATORIES

(b)(1)

Classified by Cdr, USAFSTC  
Exempt from GDS of EO 11652  
Exemption Category 1  
Declassify on IMPDET

117  
~~CONFIDENTIAL~~

707

~~CONFIDENTIAL~~

Original

MEDICAL LABORATORIES (Continued)

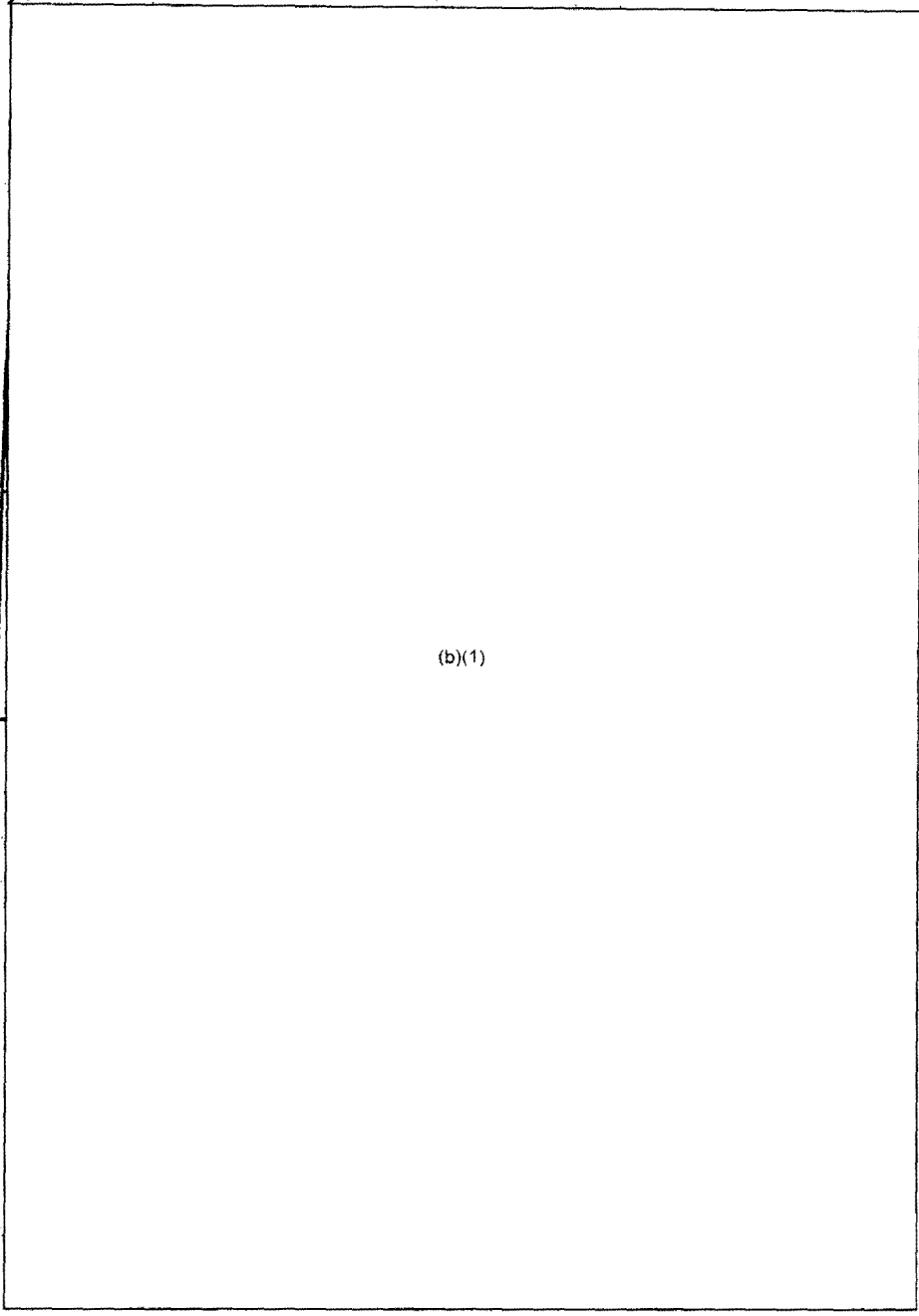

(b)(1)

~~CONFIDENTIAL~~

~~CONFIDENTIAL~~

Original

ST-CS-03-148-75

(b)(1)

MEDICAL LABORATORIES (Continued)

119

~~CONFIDENTIAL~~

709

ST-CS-03-148-75

~~CONFIDENTIAL~~

Original

MEDICAL LABORATORIES (Continued)

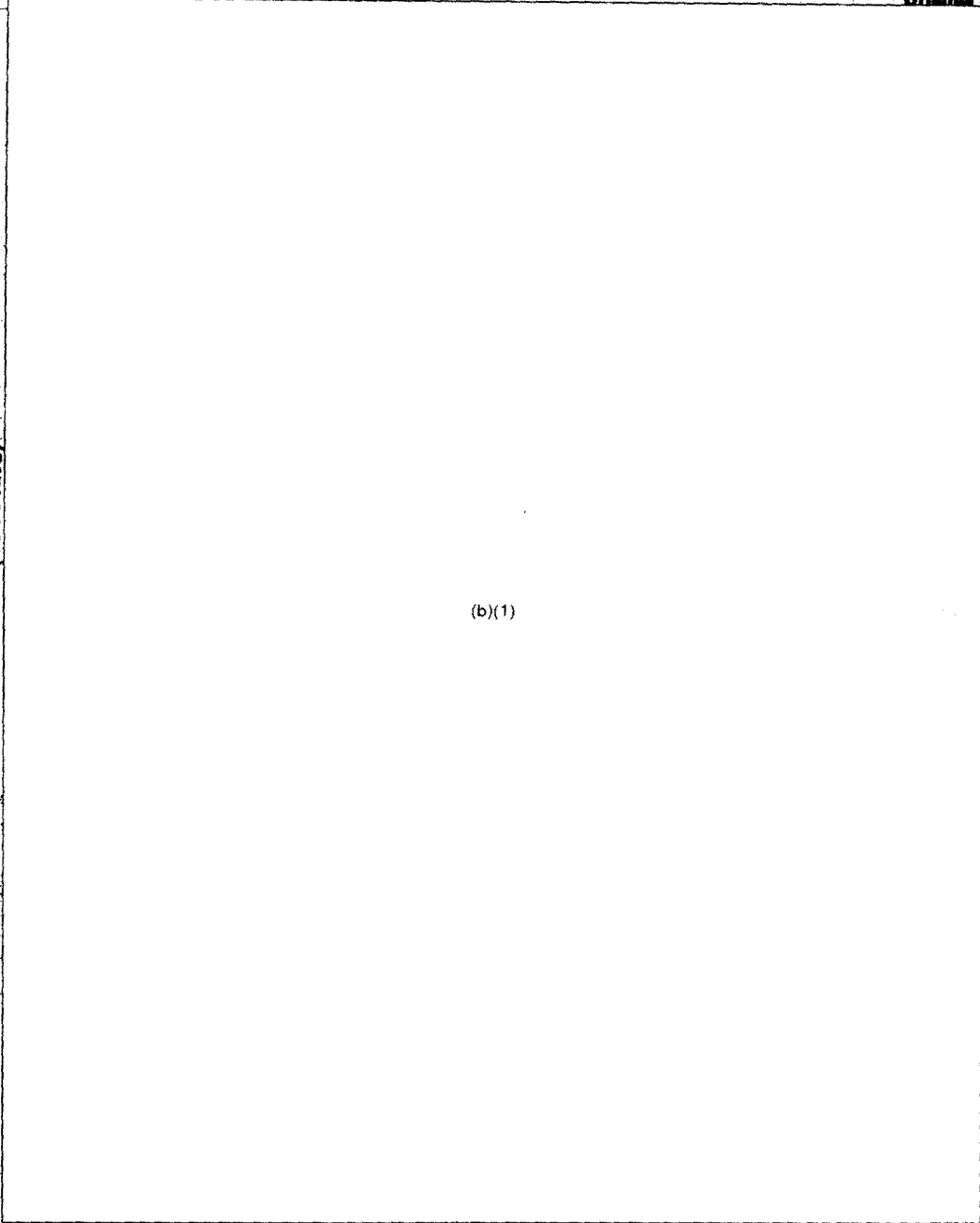

(b)(1)

120

~~CONFIDENTIAL~~

710

~~CONFIDENTIAL~~

Original

ST-CS-03-148-75

MEDICAL LABORATORIES (Continued)

(b)(1)

~~CONFIDENTIAL~~

711

ST-CS-03-148-75

~~CONFIDENTIAL~~

Original

MEDICAL LABORATORIES (Continued)

(b)(1)

122

~~CONFIDENTIAL~~

712

~~CONFIDENTIAL~~

Original  
*e*

ST-CS-03-148-75

MEDICAL LABORATORIES (Continued)

(b)(1)

123

~~CONFIDENTIAL~~

13



ST-CS-03-148-75

~~CONFIDENTIAL~~

Original

MEDICAL LABORATORIES (Continued)

(b)(1)

124

~~CONFIDENTIAL~~

714

~~CONFIDENTIAL~~

ST-CS-03-148-75

Original

~~(CONFIDENTIAL)~~

MEDICAL LABORATORIES (Continued)

(b)(1)

125

~~CONFIDENTIAL~~

715

~~CONFIDENTIAL~~

Original

ST-CS-03-148-75

(This page intentionally left blank)

126

716

~~CONFIDENTIAL~~

(This page is UNCLASSIFIED)

**UNCLASSIFIED**

Original

ST-CS-03-148-75

APPENDIX III.

FOMCAT ILLUSTRATIONS AND DESCRIPTIONS  
OF PROTECTIVE EQUIPMENT, NORTH VIETNAM

---

FOM No.	Title	Page
4230-2-3-2	Decontamination Apparatus, Truck-mounted, Model DDA-53 .....	129
4230-2-3-1	Decontamination Apparatus, Truck-mounted, Model ARS-12U .....	131

Classified by Cdr, USAFSTC  
Exempt from GDS of EO 11652  
Exemption Category 1, 2, 3  
Declassify on IMPDET

127

(Reverse Blank)

**UNCLASSIFIED**

717

UNCLASSIFIED

ST-CS-03-148-75

Original

FORM 4230-2-3-2

MODEL: DECONTAMINATION APPARATUS, TRUCK-MOUNTED, MODEL ODA-53 (0)

(OLD 2-4230-3-2)

NATIVE DES: ДЕЗИНФЕКЦИОННО - ДУШЕВАЯ УСТАНОВКА, ТДА-53  
PRODUCED/ADOPTED: /1958

COUNTRY: U.S.S.R.  
DATE UPDATED: 28AUG73

(U) THE MODEL ODA-53 TRUCK-MOUNTED DECONTAMINATION APPARATUS, ALSO REFERRED TO AS THE ADA, CONSISTS OF TWO STEAM CHAMBERS, EACH WITH TWO PRESSURE-TIGHT DOORS; AN RI-3 VERTICAL BOILER (ABOUT 200 TO 300 LITERS CAPACITY) THAT HEATS WATER AND GENERATES STEAM; A FUEL-OIL TANK (57 LITERS ESTIMATED CAPACITY, FOR 8 TO 10 HOURS' OPERATION); A PUMP FOR FILLING THE SYSTEM OR DELIVERING WATER TO POINTS OF USE; A FORMALDEHYDE TANK; A 12-HEAD PORTABLE SHOWER UNIT; AND ACCESSORIES. A SHOWER TENT IS TRANSPORTED ON A CARGO TRUCK.

(U) THIS APPARATUS CAN BE USED TO STEAM-DECONTAMINATE CLOTHING AND EQUIPMENT CONTAMINATED WITH CW AND BW AGENTS, AND TO SUPPLY HOT WATER FOR SHOWER BATHS AND FOR WASHING CONTAMINATED EQUIPMENT. FOR THE STEAM-DECONTAMINATION PROCESS, CLOTHING AND EQUIPMENT ARE SUSPENDED FROM HANGERS IN THE CHAMBERS, AND PRESSURIZED STEAM IS ADMITTED THROUGH PIPES IN THE FLOOR. AMMONIA (PARTICULARLY FOR NEUTRALIZING NERVE AGENTS), OR FORMALDEHYDE (FOR BW DECONTAMINATION), MAY BE ADDED TO THE STEAM THROUGH A VESSEL ON TOP OF EACH CHAMBER. NON-SPORE-FORMING MICROBES ARE DESTROYED WHEN EXPOSED TO STEAM AT 180 DEGREES F FOR 30 MINUTES, OR TO STEAM AND 73.9 ML OF FORMALDEHYDE AT 138 DEGREES F FOR 45 MINUTES; SPORE-FORMING ORGANISMS ARE EXPOSED TO STEAM AT 208 DEGREES F FOR 3 1/2 HOURS OR TO A MIXTURE OF STEAM AND 47.3 ML OF FORMALDEHYDE AT 138 DEGREES F FOR 2 HOURS 45 MINUTES. THE CHAMBERS CAN ATTAIN A MAXIMUM OF 212 DEGREES F.

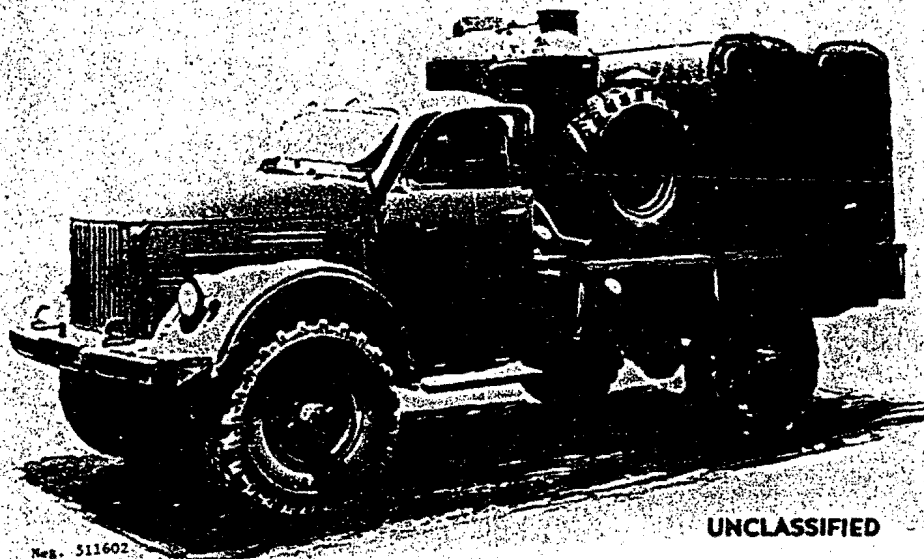

DATE CATALOGED: 01NOV69

129

UNCLASSIFIED

718

ST-CS-03-148-75

POM-4230-2-3-2

UNCLASSIFIED

Original

NAME: DECONTAMINATION APPARATUS, TRUCK-MOUNTED, MODEL DDA-53 (U)

(OLD 2-4230-3-2)

COUNTRY: U.S.S.R.

DATE UPDATED: 28AUG73

PRODUCED/ADOPTED: /1958

CURRENT STATUS: STANDARD

MAJOR COMPONENTS:

TANK ----- N/A

PUMP

-POWER DRIVEN ----- N/A

-HAND OPERATED ----- \*1

HOSE ----- RUBBER

STRAPS ----- N/A

PHYSICAL DATA:

CAPACITY

-MAXIMUM ----- \*2

-WORKING ----- \*2

WEIGHT

-FILLED ----- N/A

-EMPTY ----- N/A

DIMENSIONS

-LENGTH ----- N/A

-WIDTH ----- N/A

-HEIGHT ----- N/A

DECONTAMINANTS: ----- SEE TEXT

PERFORMANCE:

COVERAGE ----- \*2

DISCHARGE RATE ----- N/A

DISCHARGE TIME ----- N/A

OPERATING PRESSURE -- IN CHAMBERS 40.1 KG/SQ CM

PLUMBING SYSTEM: ----- \*3

GENERAL DATA:

CARRIER -----

-TYPE ----- GAZ-51 AND GAZ-63

-CAPACITY ----- ?

CREW ----- 3 ENLISTED MEN ?

MISC EQUIPMENT ----- SMOKE STACK, STEAM INJECTORS, TENTAGE, HOSES, AND PROTECTIVE CLOTHING

REMARKS: 1/ PISTON-TYPE WATER PUMP (MODEL BFK)

3/ THE 1.0 CU-METER-VOLUME STEAM CHAMBER HOLDS APPROXIMATELY 25 TO 30 SUMMER UNIFORMS, OR 20 WINTER UNIFORMS, OR 12 SHORT SHEEPSKIN COATS. BY USING DIESEL FUEL TO SUPPLY HEAT TO THE BOILER, THE DDA-53 CAN WASH AND DISINFECT HOURLY, IN SUMMER, 80 UNIFORMS CONTAMINATED WITH NONSPORE FORMING MICROBES, AND IN WINTER 40; OR IT CAN PROVIDE ENOUGH HOT WATER PER HOUR IN SUMMER FOR 90 TO 100 SHOWERS, AND IN WINTER FOR 70 TO 72. THE RATES AT WHICH CW-CONTAMINATED ITEMS ARE DECONTAMINATED ARE NOT KNOWN.

2/ THIS MODEL IS NOT EQUIPPED WITH WATER STORAGE TANKS, BUT IS SUPPLIED DIRECTLY FROM PUNDOS, STREAMS, OR MOBILE EQUIPMENT SUCH AS THE ARS-120 DECONTAMINATION APPARATUS (FOM-4230-2-3-1)

3/ METAL PIPES CONDUCT STEAM FROM THE BOILER TO THE BOTTOMS OF THE TWO STEAM CHAMBERS. RUBBER HOSES CONVEY STEAM FROM THE BOILER TO WASHING FACILITIES AND HOT WATER TO THE SHOWER FACILITIES.

DATE CATALOGED: 01NOV69

130

UNCLASSIFIED

719

Original

FOM-4230-2-3-1

UNCLASSIFIED

ST-CS-03-148-75

NAME: DECONTAMINATION APPARATUS, TRUCK-MOUNTED, MODEL ARS-12U (U)

(OLD 2-4230-3-1)

NATIVE DES: АВТОМОБИЛЬ РАЗГРЯЧИВАТЕЛЬНОЙ СИСТЕМЫ, APC-12У

COUNTRY: U.S.S.R.

PRODUCED/ADOPTED: /1962 ?

DATE UPDATED: 28AUG73

(U)THE VERSATILE MODEL ARS-12U CBR DECONTAMINATION APPARATUS, INSTALLED ON A ZIL-157 CHASSIS, CAN BE DRIVEN TO A CONTAMINATED OBJECT OR ESTABLISHED AT A DECONTAMINATION POINT TO WHICH SUCH OBJECTS ARE BROUGHT; IT IS CAPABLE OF TRANSPORTING WATER AND PUMPING IT DIRECTLY TO SHOWER HEADS; AND IT CAN SERVE AS A WATER-RESERVOIR OR WATER-SUPPLY VEHICLE FOR OTHER DECONTAMINATION EQUIPMENT THAT FURNISHES HOT WATER OR STEAM TO SHOWER UNITS, LAUNDRY FACILITIES, AND STEAM CHAMBERS. ANCILLARY EQUIPMENT THAT ADDS TO THE VERSATILITY OF THE APPARATUS IS PROVIDED FOR USE IN PERFORMING SPECIAL TASKS. FOR EXAMPLE, NOZZLES WITH JETS OF VARIOUS SIZES MAY BE ATTACHED TO THE DISCHARGE PIPE FOR ROAD AND TERRAIN DECONTAMINATION, FOR SPRAYING LARGE OR SMALL OBJECTS, OR FOR FILLING SMALL CONTAINERS. EIGHT HOSES MAY BE USED SIMULTANEOUSLY.

(U)MAJOR COMPONENTS OF THE ARS-12U INCLUDE AN OVAL-SHAPED (UNPRESSURIZED) CARGO TANK EQUIPPED WITH TWO WAVE BAFFLES, A TURNOVER GUARD, BODY WALKWAYS, PIPE HANDRAILS, A MAN-HOLE, AND A DEPTH GAGE; A SELF-PRIMING PUMP POWERED BY THE TRUCK'S ENGINE THROUGH A SPECIAL DRIVESHAFT, FOR DELIVERING 280 TO 380 LITERS OF WATER PER MINUTE AT 1400 TO 1600 DRIVESHAFT REVOLUTIONS PER MINUTE; A DOUBLE-ACTION HAND PUMP THAT DELIVERS 45 TO 56 LITERS OF WATER PER MINUTE AT 45 STROKES PER MINUTE; AND A PLUMBING SYSTEM CONSISTING OF METAL PIPES EMERGING FROM THE TOP OF THE TANK AND BEYOND FORWARD AND DOWNWARD TO CONNECT WITH THE POWER PUMP.

(U)EXCEPT FOR MINOR DIFFERENCES, THE ARS-12U IS IDENTICAL WITH THE MODEL ARS-12D, AN EARLIER VERSION OF THE DECONTAMINATION APPARATUS, WHICH WAS MOUNTED ON THE ZIL-151 CHASSIS. THE ARS-12D WAS USED ALSO TO HAUL CHLOROSULFONIC ACID AND TO DISSEMINATE IT AS SCREENING FOG; THE ARS-12U HAS BEEN RELIEVED OF THIS FUNCTION, PROBABLY BECAUSE THE ACID CORRODES THE METAL TANK AND ACCESSORIES.

DATE CATALOGED: 01NOV69

131

UNCLASSIFIED

720

ST-CS-03-148-75

FORM 4230-2-3-1

NAME: DECONTAMINATION APPARATUS, TRUCK-MOUNTED, MODEL ARS-12U (U)

UNCLASSIFIED

Original

(OLD Z-4230-3-1)  
COUNTRY: U.S.S.R.  
DATE UPDATED: 28AUG73

PRODUCED/ADOPTED: /1962 ?

CURRENT STATUS: STANDARD

PERFORMANCE:

COVERAGE ----- \*1  
DISCHARGE RATE ----- 284 TO 278 LTR  
----- MIN (MAXIMUM)  
DISCHARGE TIME ----- 7 TO 10 MIN  
OPERATING PRESSURE -- ?

MAJOR COMPONENTS:

TANK ----- SEE TEXT  
PUMP  
-POWER DRIVEN ----- GEAR-TYPE WATER PUMP  
-HAND OPERATED ----- PISTON-TYPE WATER PUMP  
HOSE ----- METAL AND RUBBER  
STRAPS ----- N/A

PLUMBING SYSTEM: -----

- RIGID METAL PIPES

PHYSICAL DATA:

CAPACITY  
-MAXIMUM ----- 2570 LTR  
-WORKING ----- ?  
WEIGHT  
-FILLED ----- ?  
-EMPTY ----- ?  
DIMENSIONS  
-LENGTH ----- ?  
-WIDTH ----- ?  
-HEIGHT ----- ?

GENERAL DATA:

CARRIER  
-TYPE ----- ZIL-157  
-CAPACITY ----- \*3  
CREW ----- NCO, DRIVER, OPERATOR  
MISC EQUIPMENT ----- \*4

DECONTAMINANTS: -----  
- \*2

REMARKS:  
1/ - A MAXIMUM OF 8 LARGE ITEM,  
SUCH AS VEHICLES OR TANKS, CAN BE  
DECONTAMINATED SIMULTANEOUSLY.

3/ - 2450 KG LIQUID AND  
EQUIPMENT.

4/ - SIX CHESTS OF ANCILLARY EQUIPMENT  
ARE CARRIED ALONG SIDE THE CARGO  
TANK. THE CHESTS CONTAIN 17 HOSES,  
INCLUDING EIGHT 60-FOOT-LONG  
DECONTAMINATION HOSES; A DISTRIBUTOR  
PIPE FOR CONNECTING THE EIGHT  
HOSES; VARIOUS TYPES OF SPRAY  
NOZZLES; BRUSHES; AND BASINS.

2/ CONTAMINATED ITEMS	CW AGENTS	DECONTAMINANTS
ROADS AND TERRAIN	MUSTARD, LEWISITE, G-AGENTS	EMULSION OF 10% CHLORIDE OF LIME AND 1% WATER GLASS IN WATER.
ROADS AND TERRAIN	MUSTARD, LEWISITE, SARIN AND SONAM	10% SOLUTION OF SULFURYL CHLORIDE IN DICHLOROETHANE (OR PETROLEUM).
COMBAT EQUIPMENT	MUSTARD, LEWISITE, V-AGENTS	10% SOLUTION OF DICHLORAMINE - T IN DICHLOROETHANE OR IN CARBON TETRACHLORIDE.
VEHICLES AND WEAPONS	G-AGENTS	2% SODIUM HYDROXIDE, 5% MONOETHANOLAMINE, AND 20% AMMONIA IN WATER.

DATE CATALOGED: 01NOV69

132

UNCLASSIFIED

721



Original  
FOM-4230-2-3-1

UNCLASSIFIED

ST-CS-03-148-75

WOMEN: DECONTAMINATION APPARATUS, TRUCK-MOUNTED, MODEL ARS-12U (U)

(OLD 2-4230-3-1)  
COUNTRY: U.S.S.R.  
DATE UPDATED: 28AUG73

PRODUCED/ADOPTED: /1962 ?

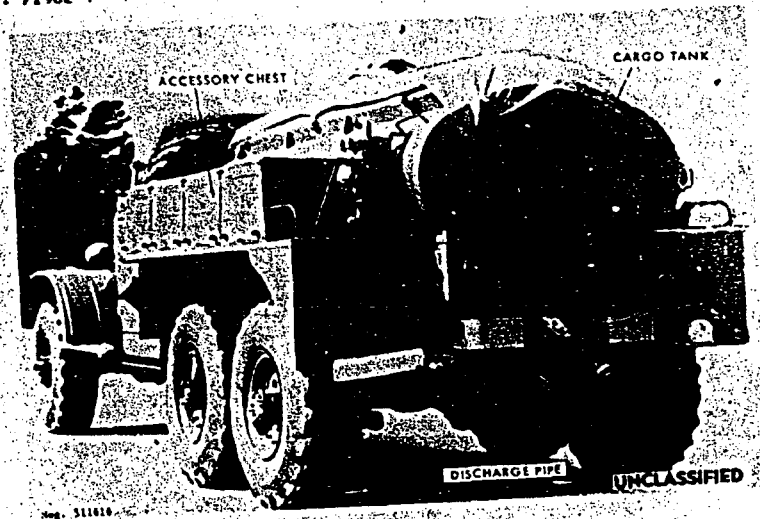

Fig. 511610

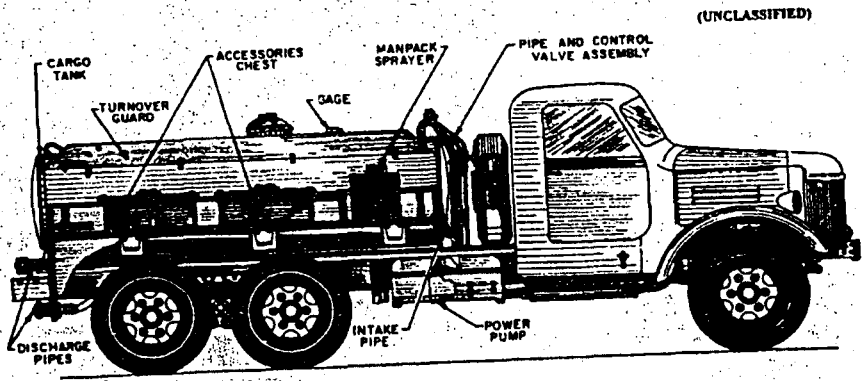

Fig. 511613

DATE CATALOGED: 01NOV69

133

(Reverse Blank)  
UNCLASSIFIED

722

~~CONFIDENTIAL~~

Original

ST-CS-03-148-75

APPENDIX IV.

SELECTED MEDICAL MATERIEL MANUFACTURERS AND  
MEDICAL LABORATORIES, NORTH VIETNAM (1971)

---

Annexes	Page
A. Manufacturers of Medical Materiel . . . . .	137
B. Medical Laboratories . . . . .	139

Classified by Cdr, USAFSTC  
Exempt from GDS of EO 11652  
Exemption Category 1  
Declassify on IMPDET

~~CONFIDENTIAL~~



~~CONFIDENTIAL~~

ST-CS-03-148-75

Original

(This page intentionally left blank)

7

136

724

~~CONFIDENTIAL~~

(This page is UNCLASSIFIED)

~~CONFIDENTIAL~~

Original

ST-CS-03-148-75

ANNEX A.

MANUFACTURERS OF MEDICAL MATERIEL.

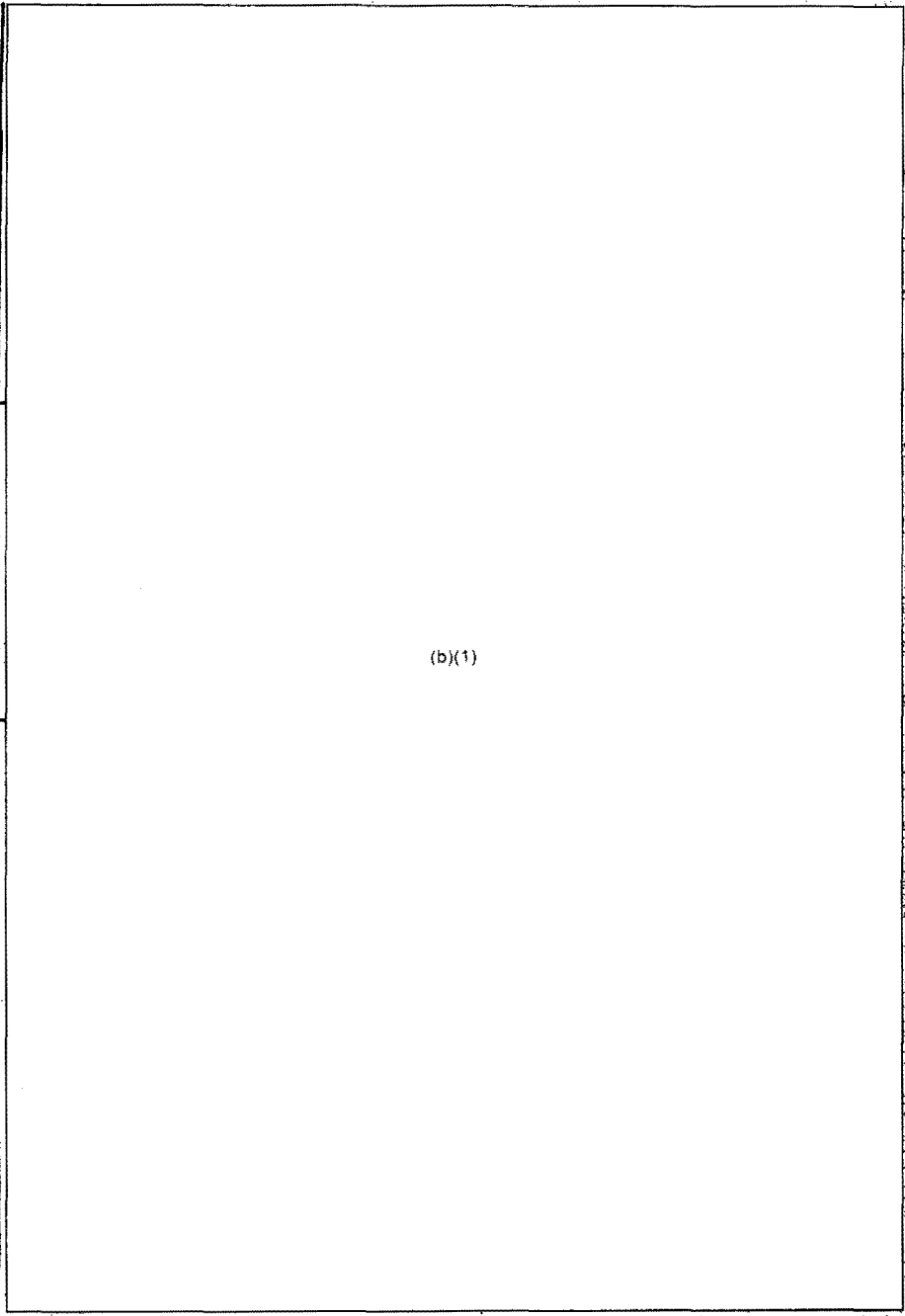

(b)(1)

137

Classified by Cdr, USAFSTC  
Exempt from GDS of EO 11652  
Exemption Category 1  
Declassify on IMPDET

~~CONFIDENTIAL~~

725

~~CONFIDENTIAL~~

ST-CS-03-148-75

Original

~~(CONFIDENTIAL)~~

MANUFACTURERS OF MEDICAL MATERIEL (Continued)

(b)(1)

138

~~CONFIDENTIAL~~

726

~~CONFIDENTIAL~~

Original

ST-CS-03-148-75

ANNEX B.  
MEDICAL LABORATORIES

(b)(1)

Classified by Cdr, USAFSTC  
Exempt from GDS of EO 11652  
Exemption Category 1  
Declassify on IMPDET

139

727

~~CONFIDENTIAL~~

~~CONFIDENTIAL~~

ST-CS-03-148-75

Original

(b)(1)

~~(CONFIDENTIAL)~~

MEDICAL LABORATORIES (Continued)

140

728

~~CONFIDENTIAL~~

~~CONFIDENTIAL~~

Original

ST-CS-03-148-75

APPENDIX V.

FOMCAT ILLUSTRATIONS AND DESCRIPTIONS OF  
PROTECTIVE EQUIPMENT, NORTH KOREA

FOM No.

Title

Page

(b)(1)

Classified by Cdr, USAFSTC  
Exempt from GDS of EO 11652  
Exemption Category 1, 2, 3  
Declassify on IMPDET

141  
729

~~CONFIDENTIAL~~



ST-CS-03-148-75

~~CONFIDENTIAL~~

Original

(This page intentionally left blank)

142  
730

~~CONFIDENTIAL~~

(This page is UNCLASSIFIED)

Original

~~CONFIDENTIAL~~

ST-CS-83-148-75

FORM 4230-2-3-3

NOMEN: DECONTAMINATION APPARATUS, TRUCK-MOUNTED, MODEL ADM-48D (U)

(OLO 2-4230-3-3)

NATIVE DES: АВТОЛГАЗАИМОННАЯ МАШИНА, АЛМ-48Д

COUNTRY: U.S.S.R.

PRODUCED/ADOPTED: 1958 ?

DATE UPDATED: 25 JUN 73

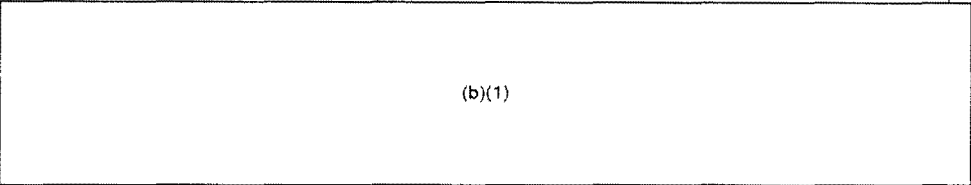

(b)(1)

(U) EACH DECONTAMINATION UNIT CONSISTS OF A CARGO TANK, A HAND PUMP, A PRESSURE-EQUALIZING TANK (TO REDUCE SURGING THAT RESULTS FROM THE SLOW-ACTING HAND PUMP), A PLUMBING SYSTEM, A METERING DEVICE, SIX 12 METER SPRAY HOSES, SIX BRUSHES, SIX NOZZLES, FOUR SUCTION HOSES, TOOLS, AND SPARE PARTS. A 64 LITER, RECTANGULAR, STEEL TANK NORMALLY FILLED WITH THE SOLVENT DICHLOROMETHANE IS STORED IN THE CARRIER.

(U) THE MODEL ADM-48D ALSO SUPPLIES WATER FOR FIELD SHOWERS AND LAUNDRY FACILITIES. IT CAN BE SET UP FOR OPERATION IN ABOUT 30 MINUTES, AND REQUIRES ABOUT 6 SQUARE METERS OF WORKING SPACE. PLACED ON THE GROUND, THE METERING DEVICE RECEIVES LIQUID DECONTAMINANT THROUGH A HOSE FROM ONE OF THE TRUCK'S TANKS AND RAPIDLY REFILLS THE EMPTY CONTAINERS OF DECONTAMINATION KITS, SUCH AS THE MODEL A-OK, (FORM 4230-2-1-4) WITH MEASURED QUANTITIES.

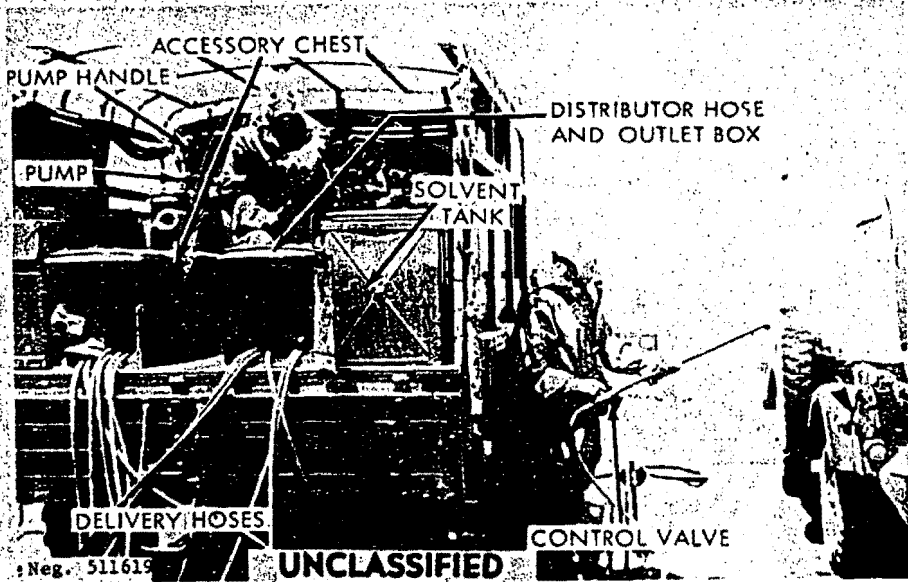

Neg. 511619

UNCLASSIFIED

DATE CATALOGED: 01NOV69

143

XGDS/1/NA

~~CONFIDENTIAL~~

731

ST-CS-03-148-75

FOM-4230-2-3-3

NOMEN: DECONTAMINATION APPARATUS, TRUCK-MOUNTED, MODEL ADM-48D (U)

PRODUCED/ADOPTED: /1958 ?

~~CONFIDENTIAL~~

Original

(OLD 2-4230-3-3)  
COUNTRY: U.S.S.R.  
DATE UPDATED: 25JUN73

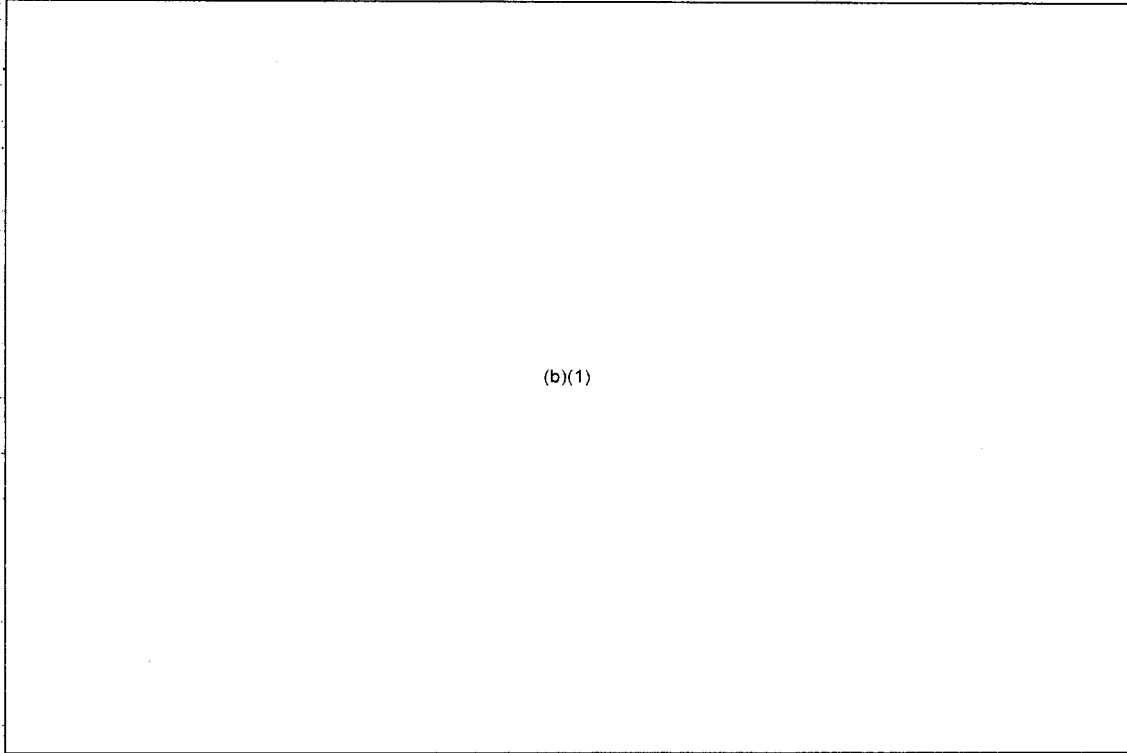

(b)(1)

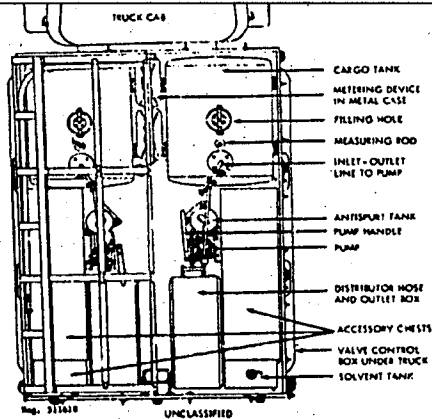

DATE CATALOGED: 01NOV69

XGDS/1/NA

~~CONFIDENTIAL~~

144  
732

UNCLASSIFIED

Original  
FOM-4230-7-3-1

ST-CS-03-148-78

NDNM: DECONTAMINATION UNIT, CLOTHING, TRUCK-MOUNTED, MODEL BU-4 (U)

(OLD 7-4230-3-1)

NATIVE DES: Bekleidungsentgiftungsanlage BU-4

COUNTRY: EAST GERMANY

PRODUCED/ADOPTED: 1960 7

DATE UPDATED: 28AUG73

(U) THE EAST GERMAN MODEL BU-4 DECONTAMINATION UNIT IS USED TO REMOVE CHEMICAL AND BIOLOGICAL CONTAMINANTS FROM COTTON CLOTHING, IMPERMEABLE PROTECTIVE CLOTHING, IMPREGNATED CLOTHING, RUBBER FACEPIECES, BOOTS, CANVAS, AND KITCHENWARE. THE UNIT'S EQUIPMENT IS COMPACTLY LOADED ON A CARGO TRUCK, WHICH IS EQUIPPED WITH A CRANE, AND IS LOWERED TO THE GROUND FOR USE. THE TRUCK BODY IS WOODEN (TO RESIST CORROSION) AND IS MOUNTED ON TYPE GAZ-51 (FOM-2320-2-4-21, GAZ-63 (FOM-2320-2-4-31), OR LO-1800 (FOM-2320-7-4-11) CHASSIS.

(U) THE UNIT HAS TWO IDENTICAL BOILERS. ITEMS TO BE DECONTAMINATED ARE LOADED IN LAUNDRY TRAYS AND LOWERED INTO THE BOILERS. IF THE DECONTAMINATION IS TO BE ACCOMPLISHED BY ADDING AMMONIA TO THE WATER, THE BOILERS ARE COVERED, AND THE CONTAMINATED ARTICLES ARE PLACED ON SCREENS ABOVE THE SOLUTION AND ARE THEN PERMEATED BY STEAM AND AMMONIA VAPORS. ARTICLES MAY ALSO BE DECONTAMINATED BY IMMERSION IN BOILING WATER.

(U) THE BU-4 MAY BE AN IMPROVED VERSION OF THE SOVIET MODELS BU-2 (FOM-4230-2-3-9) AND THE BU-3.

(UNCLASSIFIED)

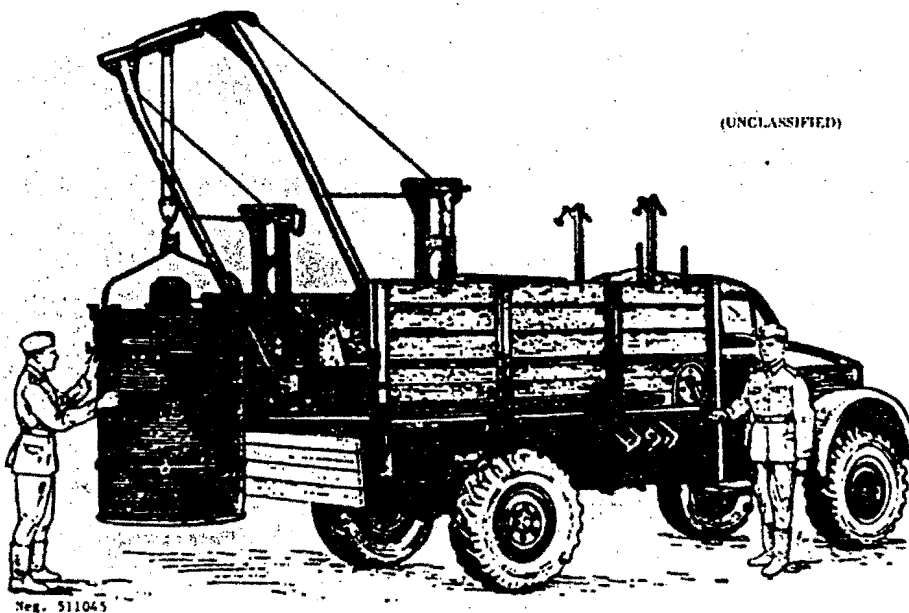

Fig. 511045

DATE CATALOGED: 01SEP67

145

UNCLASSIFIED

733

ST-CS-83-148-75

FOM-4230-7-3-1

UNCLASSIFIED

Original

NOMEN: DECONTAMINATION UNIT, CLOTHING, TRUCK-MOUNTED, MODEL BU-4 (U)

IOLD 7-4230-3-11  
COUNTRY: EAST GERMANY  
DATE UPDATED: 28AUG73

PRODUCED/ADOPTED: /1960 ?

CURRENT STATUS: STANDARD

PERFORMANCE:  
COVERAGE ----- N/A  
DISCHARGE RATE ----- N/A  
DISCHARGE TIME ----- N/A  
OPERATING PRESSURE -- N/A

MAJOR COMPONENTS:

TANK ----- #1  
PUMP  
-POWER DRIVEN ----- N/A  
-HAND OPERATED ----- #2  
HOSE ----- RUBBER  
STRAPS ----- N/A

PLUMBING SYSTEM: ----- ?

PHYSICAL DATA:

CAPACITY  
-MAXIMUM ----- 567 LITERS  
-WORKING ----- N/A  
WEIGHT  
-FILLED ----- ?  
-EMPTY ----- ?  
DIMENSIONS  
-LENGTH ----- ?  
-WIDTH ----- ?  
-HEIGHT ----- ?

GENERAL DATA:

CARRIER  
-TYPE ----- SEE TEXT  
-CAPACITY ----- SEE TEXT  
CREW ----- 7  
MISC EQUIPMENT ----- PRESS, HAND PUMP, 2 CANVAS  
-WATER CONTAINERS OF  
-1003 LTR & 1192 LTR CAP.  
-RESPECTIVELY

DECONTAMINANTS: ----- WATER, SODA AND WATER,  
- (SEE TEXT)

REMARKS:  
1/ 2 DECONTAMINATING BOILERS, CRANE, DRYING  
APPARATUS, RUBBERIZED CURTAINS, WATER  
TANK  
2/ 1 HAND PUMP TO SUPPLY UNIT WITH WATER

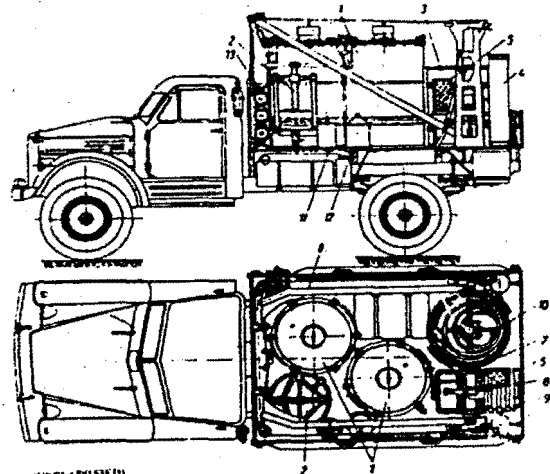

(UNCLASSIFIED)

- |                            |                             |                                     |
|----------------------------|-----------------------------|-------------------------------------|
| 1. DECONTAMINATION BOILERS | 5. LAUNDRY TRAYS            | 9. BENCHES                          |
| 2. DRYING PRESS            | 6. CRANE                    | 10. HOSE                            |
| 3. WATER TANK              | 7. BOX (TOOLS, SPARE PARTS) | 11. PAIS                            |
| 4. SMOKESTACK              | 8. WATER PUMP (MANUAL)      | 12. CONTAINER (SODA?)               |
|                            |                             | 12. STAKES AND PEGS FOR DRYING TENT |

Fig. 511044

DATE CATALOGGED: 01SEP67

146

UNCLASSIFIED

734

Original

~~CONFIDENTIAL~~

ST-CS-03-148-75

FORM 4230-2-3-4

NAME: DECONTAMINATION APPARATUS, TRAILER MOUNTED, MODEL DDP (U)

(OLD 2-4230-3-4)

NATIVE DESI ?  
PRODUCED/ADOPTED: 1/1962?

COUNTRY: U.S.S.R.  
DATE UPDATED: 28AUG73

(b)(1)

(CLOTHING AND EQUIPMENT CONTAMINATED WITH CW OR BW AGENTS ARE SUSPENDED FROM HANGERS IN THE STEAM CHAMBER, TO WHICH PRESSURIZED STEAM IS ADMITTED THROUGH PIPES IN THE FLOOR. TO EXPEDITE CW, ESPECIALLY NERVE AGENT DECONTAMINATION, AN OPEN VESSEL OF AMMONIA MAY BE PLACED IN THE CHAMBER TO VAPORIZE WITH THE STEAM; THE VESSEL MAY BE FILLED WITH FORMALDEHYDE TO REDUCE THE TIME FOR DESTROYING BW AGENTS. NONSPORE-FORMING MICROBES ARE EXPOSED TO STEAM AT 83 DEG. C. FOR 0.5 HOUR, OR TO STEAM AND 0.5 LTR OF FORMALDEHYDE AT 59 DEG. C. FOR 0.75 HOURS; SPORE-FORMING ORGANISMS ARE DESTROYED IN STEAM AT 98 DEG. C. FOR 3 TO 3.5 HOURS, OR IN A MIXTURE OF STEAM AND 0.5 LITER FORMALDEHYDE AT 59 DEG. C. FOR 2.75 HOURS.

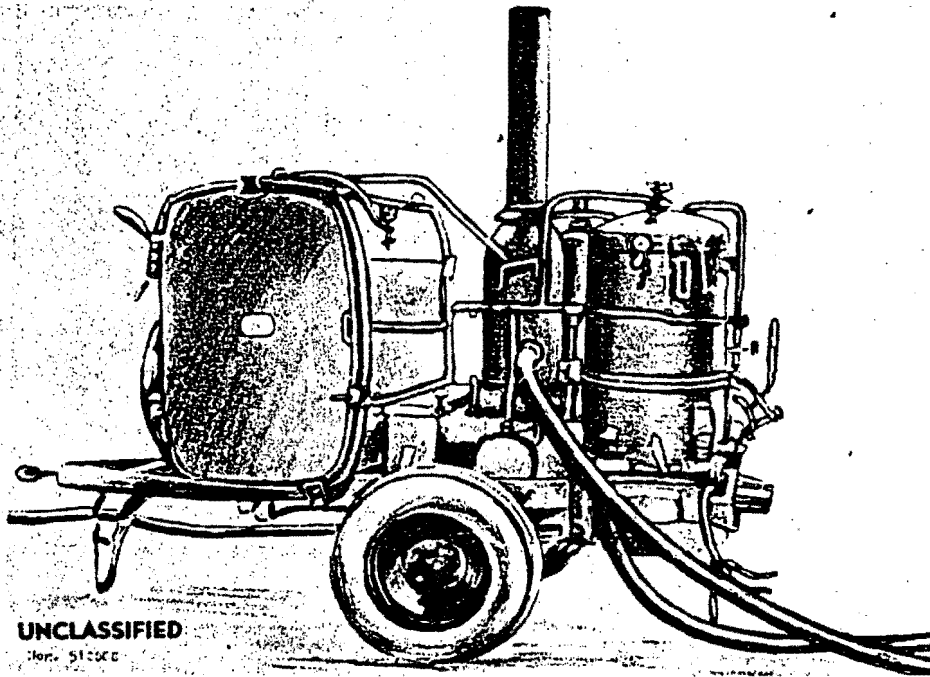

UNCLASSIFIED

Rev. 51000

DATE CATALOGED: 01DEC66

147

KGDS/Z/NA

~~CONFIDENTIAL~~

735

ST-CS-03-148-75

FOM-4230-2-3-4

~~CONFIDENTIAL~~

WOMEN: DECONTAMINATION APPARATUS, TRAILER MOUNTED, MODEL DDP (C)

FORM 2-4230-3-41

Original

COUNTRY: U.S.S.R.

PRODUCED/ADOPTED: 1962

DATE UPDATED: 1962

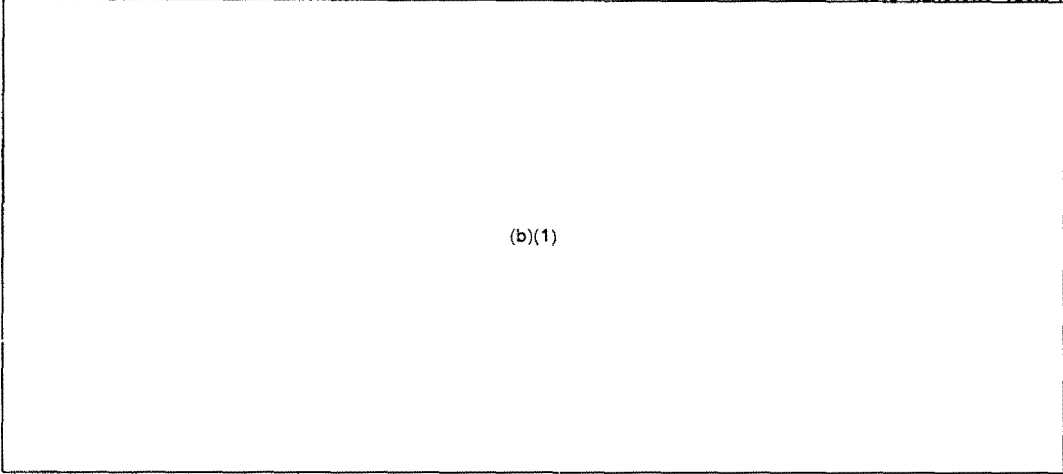

(b)(1)

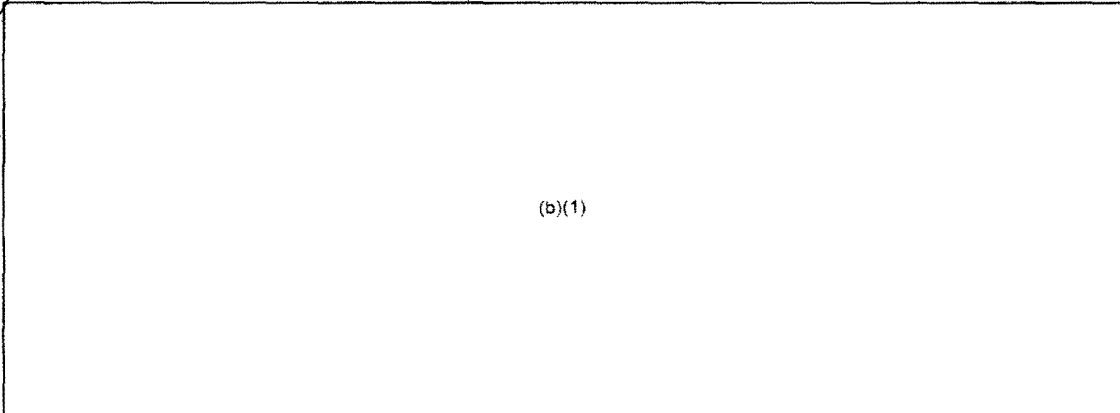

(b)(1)

DATE CATALOGED: 010EC66

148

XGDS/2/NA

~~CONFIDENTIAL~~

736

**Original**  
FOM-4230-2-1-7  
NOMEN: DECONTAMINATION KIT, INDIVIDUAL, MODEL 1PP (U)  
NATIVE DES: 7  
PRODUCED/ADOPTED: 7/1960 7

~~CONFIDENTIAL~~

ST-CS-03-148-75

(OLD 2-4230-1-7)

COUNTRY: U.S.S.R.  
DATE UPDATED: 19SEP73

(U) THE MODEL 1PP KIT, WHICH IS CARRIED IN THE PROTECTIVE MASK CARRIER, IS PROVIDED FOR TREATING SMALL AREAS OF SKIN AND CLOTHING CONTAMINATED WITH CW NERVE AGENTS OR VESICANTS. IT IS ALSO USEFUL AGAINST BW AGENTS.

(b)(1)

(U) FOUR ANTISMOKE GAUZE-WRAPPED AMPOULES, EQUIPPED WITH PULL STRINGS, ARE STORED IN AN X SHAPED COMPARTMENT. FOR USE, AN AMPOULE IS INSERTED INTO THE MASK FACEPIECE AND CAUSHED, AND THE FUMES ARE INHALED TO NULLIFY THE EFFECTS OF IRRITANT SMOKE. THE INHALANT IS COMPOUNDED OF 40 ML OF ETHANOL, 63 ML OF CHLOROFORM, 20 ML OF ETHYL ETHER, AND 10 DROPS OF STRONG AMMONIA WATER.

(U) THE 1PP, POSSIBLY ALSO REFERRED TO AS THE 1PP-51, IS BELIEVED TO SUPERSEDE THE 1PP-3, WHICH CONTAINED A DECONTAMINANT FOR VESICANTS ONLY.

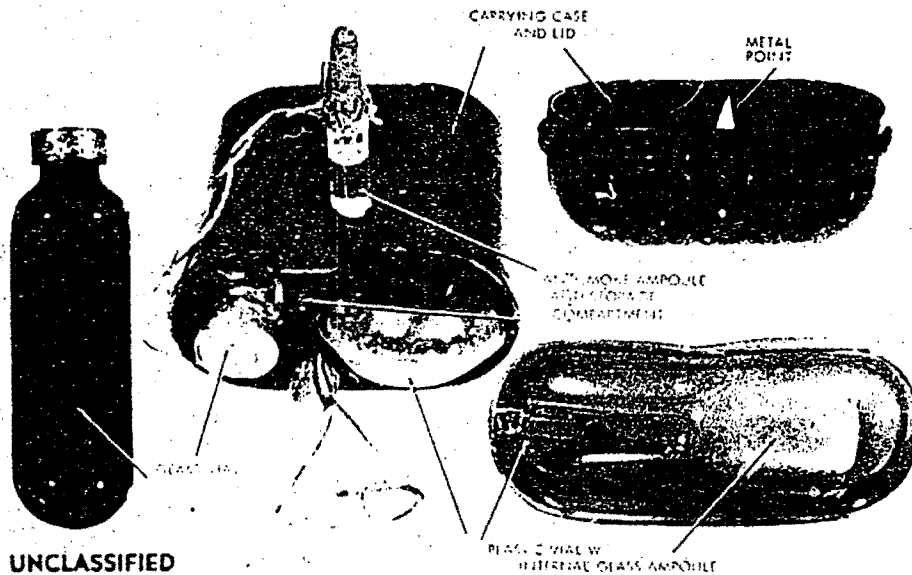

DATE CATALOGED: 01AUG68

149

XG05/Z/NA

~~CONFIDENTIAL~~

737



ST-CS-03-148-75

FORM 4230-2-1-7

NUMER: DECONTAMINATION KIT, INDIVIDUAL, MODEL (PP (C))

~~CONFIDENTIAL~~

Original

PROJCE/ACPTED: /1960 ?

IGLO 2-6230-1-71  
COUNTRY: U.S.S.R.  
DATE UPDATED: 19SEP73

CURRENT STATUS: STANDARD

(b)(1)

REMARKS:

(b)(1)

DATE CATALOGED: 01AUG68

150  
~~CONFIDENTIAL~~

XCOS/2/NA

738

~~CONFIDENTIAL~~

Original

ST-CS-03-148-75

APPENDIX VI.

SELECTED MEDICAL MATERIEL MANUFACTURERS AND  
MEDICAL LABORATORIES, NORTH KOREA (1971)

---

Annexes	Page
A. Manufacturers of Medical Materiel . . . . .	153
B. Medical Laboratories . . . . .	154

Classified by Cdr. USAFSTC  
Exempt from GDS of EO 11652  
Exemption Category 1, 3  
Declassify on IMPDET

~~CONFIDENTIAL~~

ST-CS-03-148-75

**CONFIDENTIAL**

Original

(This page intentionally left blank)

152  
740

**CONFIDENTIAL**

(This page is UNCLASSIFIED)

~~CONFIDENTIAL~~

Original

ST-CS-03-148-75

ANNEX A.

MANUFACTURERS OF MEDICAL MATERIEL

(c)

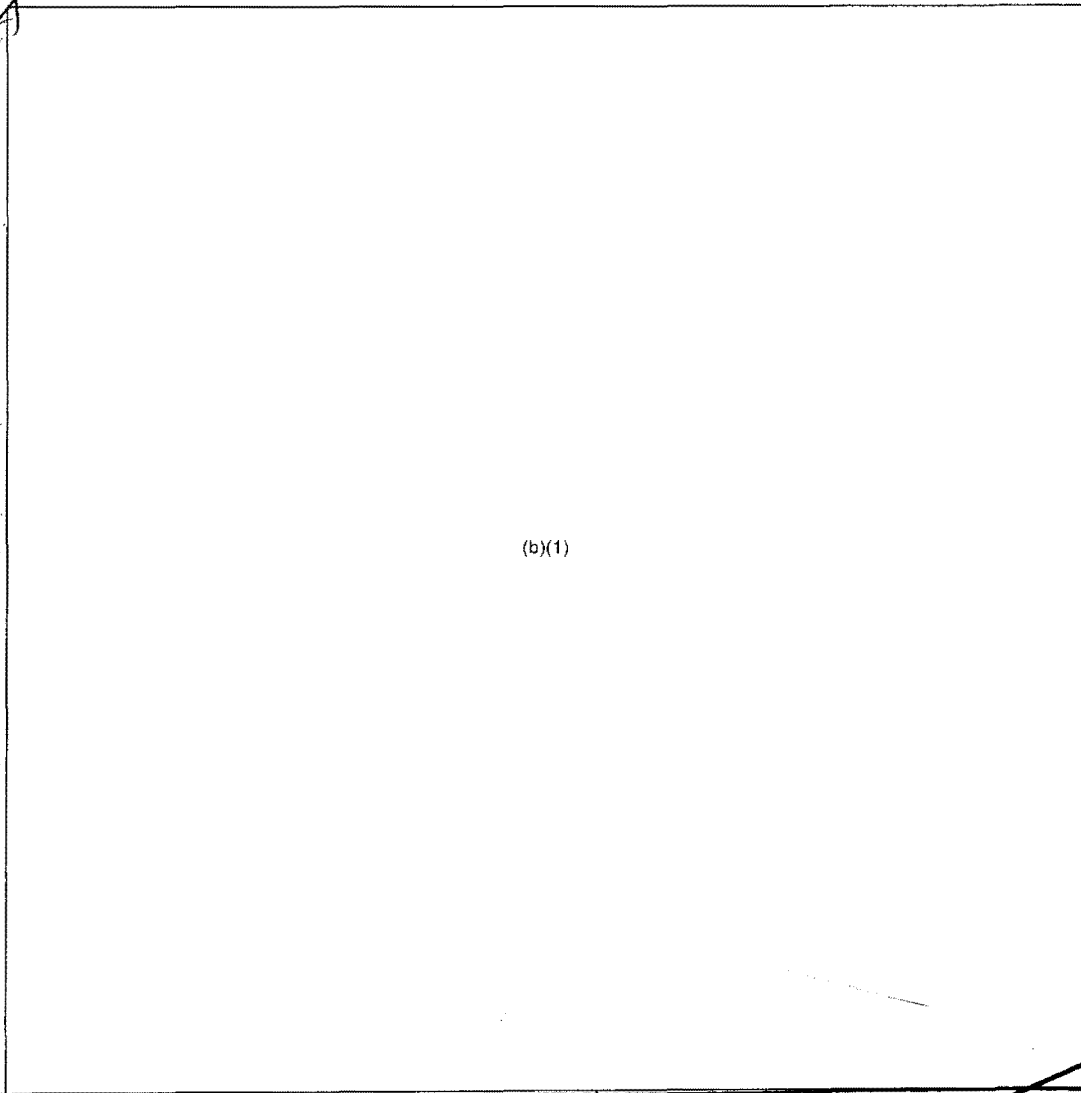

(b)(1)

\*Data not available

~~(CONFIDENTIAL)~~

Classified by Cdr, USAFSTC  
Exempt from GDS of EO 11652  
Exemption Category 3  
Declassify on IMPDET

153

~~CONFIDENTIAL~~

741

~~CONFIDENTIAL~~

ST-CS-03-148-75

Original

~~(S)~~

~~(CONFIDENTIAL)~~

ANNEX B.  
MEDICAL LABORATORIES

(b)(1)

Classified by Cdr, USAFSTC  
Exempt from GDS of EO 11652  
Exemption Category I  
Declassify on IMPDET

154

~~CONFIDENTIAL~~

742

~~CONFIDENTIAL~~

ST-CS-03-148-75

Original

APPENDIX VII.  
SELECTED MEDICAL MATERIEL MANUFACTURERS,  
MONGOLIAN PEOPLES REPUBLIC (1971)

(b)(1)

155

Classified by Cdr, USAFSTC  
Exempt from GDS of EO 11652  
Exemption Category 1  
Declassify on IMPDET

~~CONFIDENTIAL~~

743

~~CONFIDENTIAL~~

ST-CS-03-148.75

Original

SELECTED MEDICAL MATERIEL MANUFACTURERS,  
MONGOLIAN PEOPLES REPUBLIC (1971) (Continued)

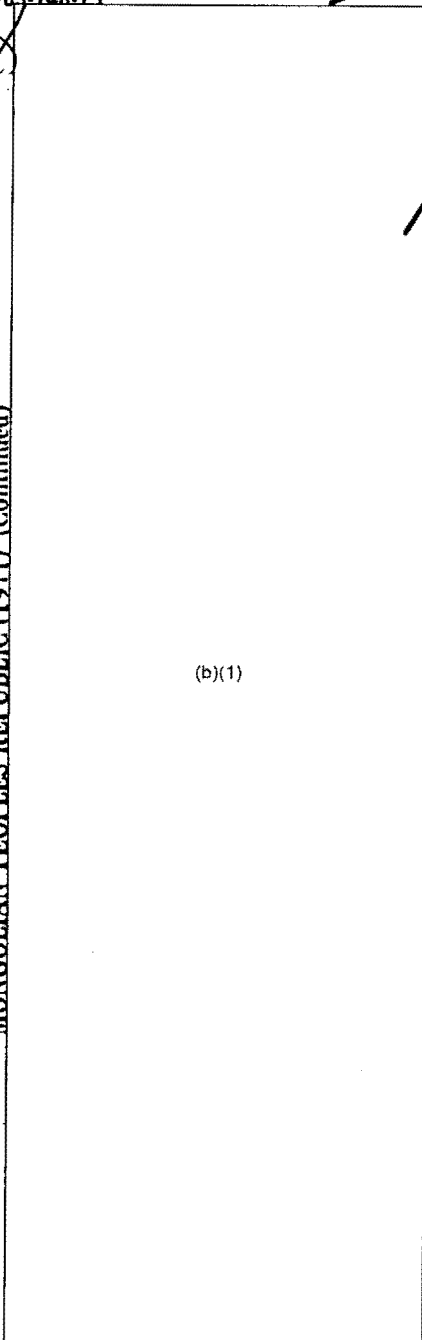

~~(CONFIDENTIAL)~~

(b)(1)

156

~~CONFIDENTIAL~~

744

UNCLASSIFIED

SECURITY CLASSIFICATION OF THIS PAGE (When Data Entered)

REPORT DOCUMENTATION PAGE		READ INSTRUCTIONS BEFORE COMPLETING FORM
1. REPORT NUMBER ST-CS-03-148-75	2. GOVT ACCESSION NO.	3. RECIPIENT'S CATALOG NUMBER
4. TITLE (and Subtitle) BIOLOGICAL WARFARE CAPABILITIES--ASIAN COMMUNIST COUNTRIES (U)		5. TYPE OF REPORT & PERIOD COVERED Trend study, Group I, Annual.
		6. PERFORMING ORG. REPORT NUMBER FSTC T74-03-09-51
7. AUTHOR(s) <div style="border: 1px solid black; width: 150px; height: 20px; margin: 5px auto; text-align: center;">(b)(6)</div>	8. CONTRACT OR GRANT NUMBER(s)	
9. PERFORMING ORGANIZATION NAME AND ADDRESS Foreign Science and Technology Center US Army Materiel Command Department of the Army		10. PROGRAM ELEMENT, PROJECT, TASK AREA & WORK UNIT NUMBERS <div style="border: 1px solid black; width: 100px; height: 20px; margin: 5px auto; text-align: center;">(b)(3):10 U.S.C. 424</div>
		12. REPORT DATE July 1974
11. CONTROLLING OFFICE NAME AND ADDRESS		13. NUMBER OF PAGES 175
		15. SECURITY CLASS. (of this report) SECRET-NFD
14. MONITORING AGENCY NAME & ADDRESS (if different from Controlling Office)		15a. DECLASSIFICATION/DOWNGRADING SCHEDULE XGDS-1, 2, 3
		16. DISTRIBUTION STATEMENT (of this Report) In addition to any security requirements which apply to this document and must be met, each transmittal outside the Department of Army must have prior approval of the Defense Intelligence Agency. This document is not releasable to the Defense Documentation Center.
17. DISTRIBUTION STATEMENT (of the abstract entered in Block 20, if different from Report) Distribution is unlimited.		
18. SUPPLEMENTARY NOTES This study supersedes ST-CS-03-148-72, as amended.		
19. KEY WORDS (Continue on reverse side if necessary and identify by block number) Biological Warfare    Biological Warfare Development Programs Order of Battle for Biological Warfare                            Biological Warfare Agents Biological Warfare Materiel    Decontamination Biological Warfare Doctrine    Agent Prophylaxis <p style="text-align: center;">(See Reverse Side)</p>		
20. ABSTRACT (Continue on reverse side if necessary and identify by block number) See reverse side of this page.		

745



UNCLASSIFIED

SECURITY CLASSIFICATION OF THIS PAGE(When Data Entered)

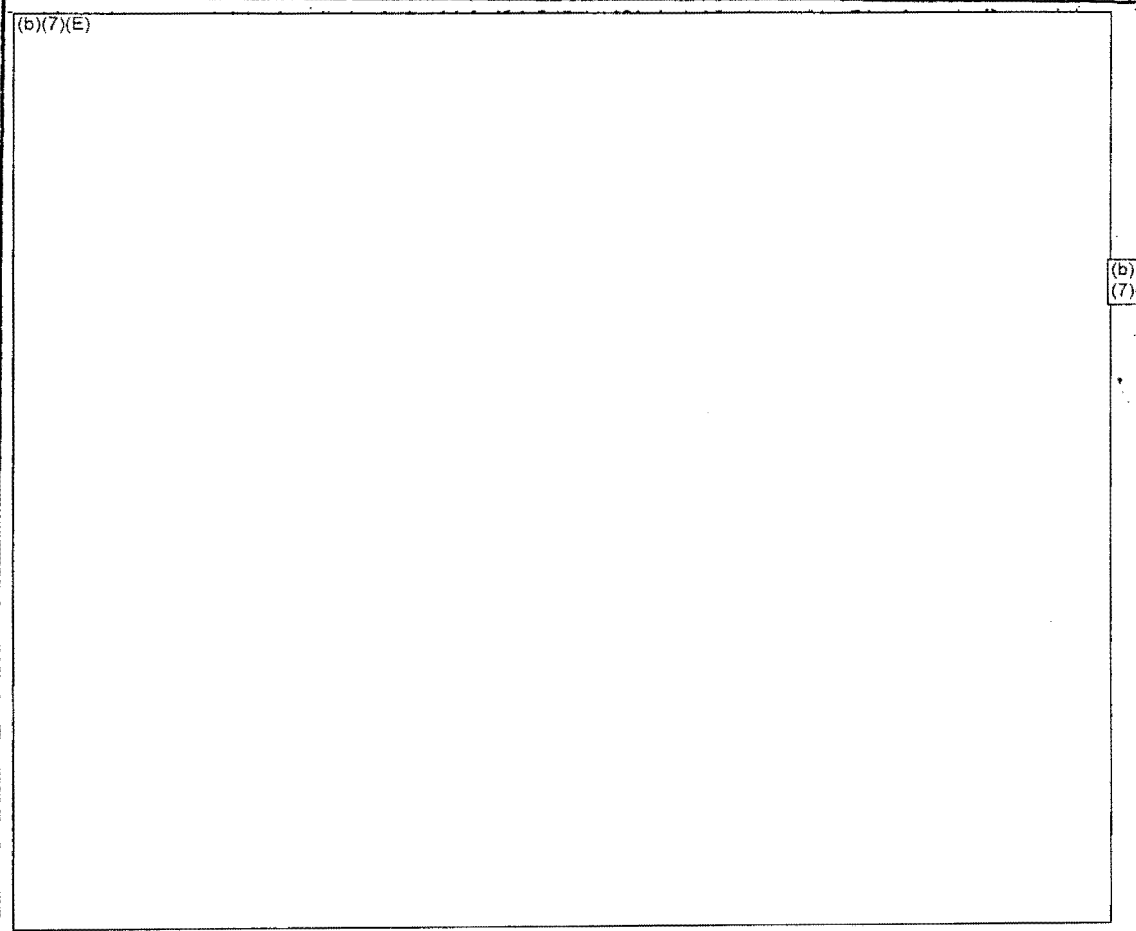

(b)(7)(E)

(b)  
(7)(

746